



**CQ MEDICAL™**

Formerly CIVCO RT™ and Qfix®

**2023-24 v1  
INNOVATIONS  
GUIDE**

## GLOBAL ORDERING INFORMATION

Dear Valued Customer,

As we work to combine our ordering systems, we cannot accept combined purchase orders for CIVCO RT and Qfix legacy products. Purchase orders must continue to be submitted separately. We are diligently working towards one system and will notify you when that occurs. Thank you for understanding!

### CIVCO RT LEGACY PRODUCTS

**CIVCO RT legacy part numbers are anything besides “RT-” (for example, anything beginning with MT, BPL, OAP, or a whole number).**

#### CUSTOMER CARE

Toll-free within the U.S. and Canada: **800.842.8688**

Direct Dial: **+1 712.737.8688**

Facsimile: **877.613.6300**

Direct Sales Email: **CRTorder@CQmedical.com** or **order@CivcoRT.com**

Distributor Sales Email: **distorder@CQmedical.com**

OEM Email: **oemorder@CQmedical.com**

#### OFFICE HOURS

Monday – Thursday, 7:30 a.m. – 5:00 p.m.,  
Friday 7:30 a.m. – 4:00 p.m. U.S. Central Time.

### QFIX LEGACY PRODUCTS

**Qfix legacy part numbers begin with “RT-”.**

#### CUSTOMER CARE

Toll-free within the U.S. and Canada: **800.526.5247**

Direct Dial: **+1 610.268.0585**

Facsimile: **610.268.0588** or **800.831.8174**

Direct Sales Email: **Qsales@CQmedical.com** or **Sales@Qfix.com**

#### OFFICE HOURS

Monday – Friday 7:30 a.m. – 5:30 p.m.  
U.S. Eastern Time.

### SHIPPING

Shipping is the responsibility of the customer. Refer to the applicable legacy CIVCO RT or Qfix Standard Terms and Conditions\* for more information.

### PRICING

Prices are subject to change without notice. Minimum purchase quantities or amounts may apply. Please contact Customer Care for details.

### SAMPLE REQUESTS

Free non-sterile samples are available on selected products. Samples are provided for sizing and fit purposes only and should not be used in clinical procedures.

### RETURN POLICY

If the merchandise you received is defective or not as you ordered, please contact Customer Care within 30 days of invoice date for assistance. Returned products may be subject to additional restocking fees. Please refer to the applicable legacy CIVCO RT or Qfix Standard Terms and Conditions\* for more information.

### CLAIMS, SHORTAGES OR DAMAGES

Open all shipments immediately and inspect for concealed damages, shortages or errors. If goods were damaged in shipping, please hold the package and request a carrier inspection and claim form. Please report any shortages or errors to Customer Care within 30 days of receipt of shipment.

### PRODUCT WARRANTY

Product warranty information is available on the legacy CIVCO RT and Qfix websites ([www.CivcoRT.com](http://www.CivcoRT.com), [www.Qix.com](http://www.Qix.com)).

### QUALITY STANDARDS

Legacy CIVCO RT and Qfix comply with ISO 13485:2016 Quality Standards. Note: Not all products listed are available in every market. Please contact your account representative or local distributor for availability.

\*Terms and conditions subject to change without notice. Contact legacy CIVCO RT or Qfix Customer Care for most updated terms and conditions.

## A NEW NAME, A NEW GLOBAL LEADER



This Innovations Guide marks a defining moment in the inaugural chapter of our new company, CQ Medical.

With it, we are bringing together the innovations of our two legacy companies, CIVCO RT and Qfix. Under one roof, we have a **combined 80 years of experience**, making significant impact on medical treatment and care, and a profound difference in patients' lives. We have brought together the best of each organization, from developers and designers to scientists and fabricators.

This makes us the **new global leader** in patient radiotherapy positioning and healthcare innovations that advance human care.

We have a new look, a new feel, and a new mantra to **Care Smarter**. As you'll see demonstrated throughout this Innovations Guide, our products uniquely combine medical technology with empathy for the patient. To our way of thinking, that's the better way to achieve better outcomes.

This is an exciting time for us. And for you. We look forward to providing you with all the **innovations that make you and your patients better**. We invite you to peruse the following pages for the products you've come to trust, and look forward to what's on the horizon.

If you have any questions, please email us at [info@CQmedical.com](mailto:info@CQmedical.com).



7-25

COUCHTOPS  
& OVERLAYS

28-34

SYMPHONY® IMAGING,  
TREATMENT &  
TRANSFER SOLUTION

35-40

ALL IN ONE  
SOLUTIONS

41-55

SBRT  
(STEREOTACTIC  
BODY RADIATION  
THERAPY)

151-164

VACUUM &  
POSITIONING  
CUSHIONS

165-171

FIDUCIAL MARKERS

172-179

PATIENT MARKING

180-188

MRSERIES™

58-67

SRS/SRT  
(STEREOTACTIC  
RADIOSURGERY/  
RADIOTHERAPY)

70-115

HEAD & NECK AND  
THERMOPLASTICS

118-137

BREAST & THORAX

138-150

HIP, PELVIS &  
EXTREMITIES

189-204

PROTONSERIES®

205-214

ACCESSORIES,  
AIDS & STORAGE



# IQ + EQ = CQ

We care with our hearts.  
With our actions.  
It comes from the deep well of empathy  
that lives inside us all.  
But we also care with our minds.  
With our designs and our discipline.  
It's in the intelligence with which we  
approach what we do.  
Making treatment more precise,  
Technologies more effective,  
The genius minds of medicine more brilliant.  
Advancing the cause of health forward.  
This combination of intelligence and emotion  
can be found in every one of our designs,  
in all our people, and everything we do.  
It is this coming together of IQ and EQ  
that makes us unique.  
That makes us CQ Medical.  
To us, care is more than an emotion,  
It is a decision.  
Which is what makes us the global leader  
in patient radiotherapy positioning and  
healthcare innovation.  
Because we care smarter than anyone.  
And make care smarter for everyone.

 **CQ MEDICAL™**  
Care Smarter  
Formerly CIVCO RT™ and Qfix®

# CQ MEDICAL EDUCATION CENTER

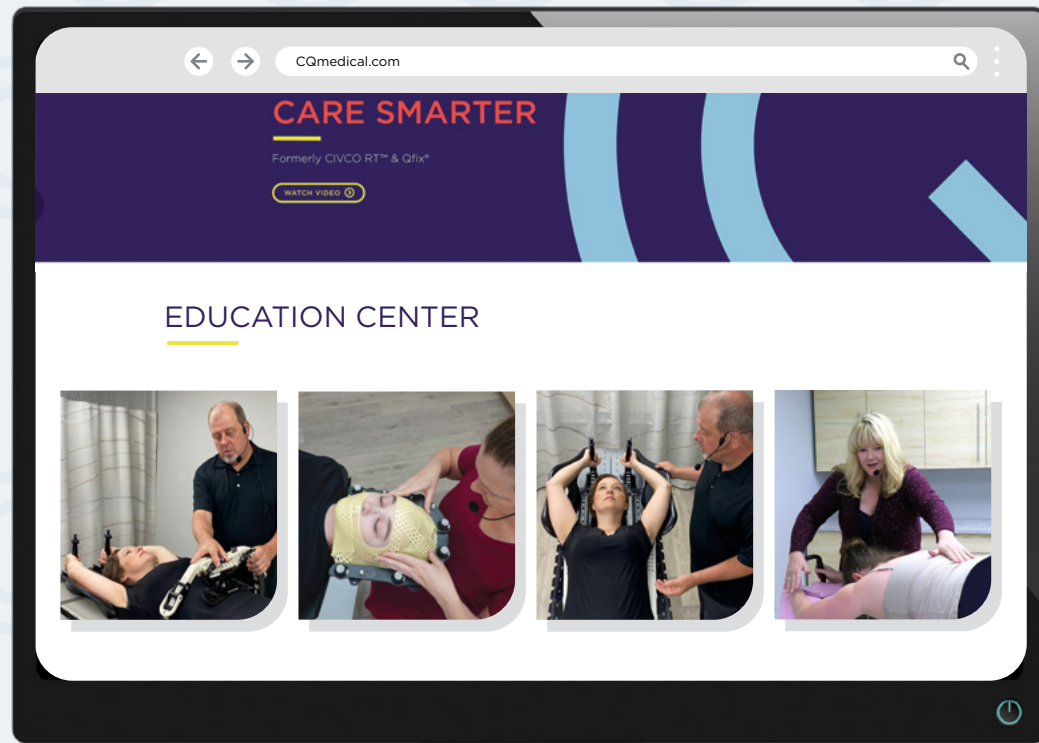

The CQ Medical Education Center is designed to **simulate a clinical environment** and **facilitate virtual demonstrations**. The center allows us to provide **uninterrupted support** to our clinical partners around the world.

One of the greatest benefits of an interactive, web-based session is the ability to showcase a variety of legacy Qfix and legacy CIVCO RT positioning & immobilization solutions and treatment options. It helps us understand your current workflow so that we can **focus on the device and techniques that work best for you**.

We are excited to offer a live learning resource to our customers & partners!

**SCHEDULE A LIVE WEB-BASED DEMO OR TRAINING TODAY!**  
**CONTACT EDUCATION@CQMEDICAL.COM OR YOUR REGIONAL SALES MANAGER**

## Couchtops & Overlays



# COUCHTOPS & OVERLAYS



9-12

UNIVERSAL COUCHTOP  
LONG EXTENSION AND  
1 PIECE

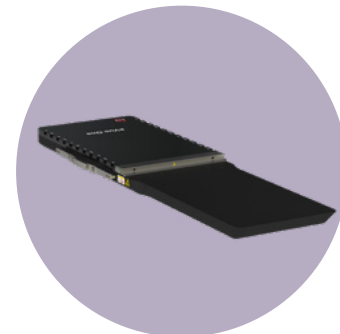

13-18

KVUE COUCHTOPS



19-20

CT OVERLAYS



21-23

LOK-BARS AND  
LOCATING BARS



24-25

KVUE AND UNIVERSAL  
COUCHTOP ACCESSORIES



24

COUCHTOP PADS

# Universal Couchtop™ Long Extension

## JUNCTION, RAIL AND ARTIFACT-FREE

The Universal Couchtop is a modern and comprehensive solution for enabling advanced treatments in your clinic. Specifically designed to answer the demands of IGRT delivery, the Universal Couchtop Long Extension contains no rails or junctions in the treatment area to help facilitate better dose delivery and target coverage.

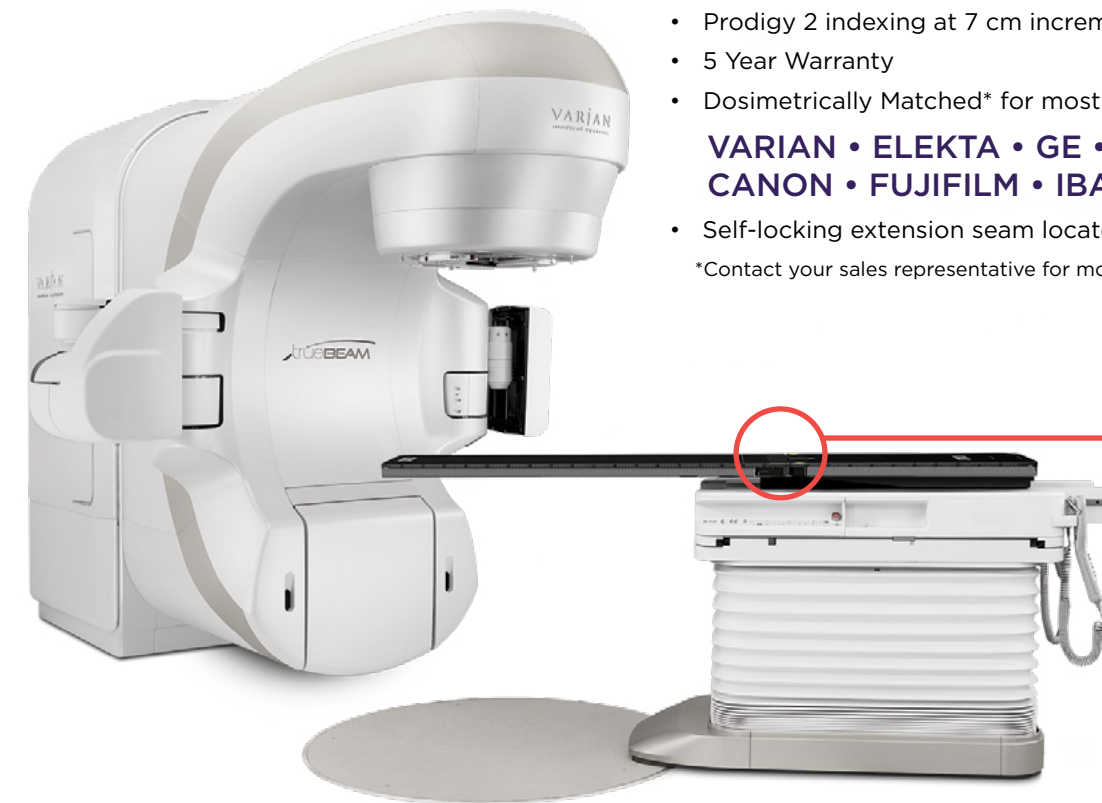

- Large treatment area
- No support mechanism to move or account for in planning
- Low attenuation and surface dose
- Prodigy 2 indexing at 7 cm increments
- 5 Year Warranty
- Dosimetrically Matched\* for most major CT, LINAC and Proton models

**VARIAN • ELEKTA • GE • PHILIPS • SIEMENS  
CANON • FUJIFILM • IBA • HITACHI • MEVION**

- Self-locking extension seam located outside of treatment field
- \*Contact your sales representative for more information.

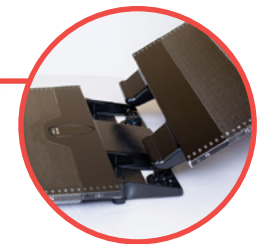

## EXTENSIONS ALLOW TREATMENT OF MANY DISEASE SITES

Solstice, Type-S and Posifix Thermoplastics, ONEBridge, Body Pro-Lok Bridges, Respiratory Belt and many additional solutions attach directly to the Universal Couchtop.





## Universal Couchtop Long Extension

### CT COMPATIBILITY

GE Discovery ST	MTIL6341
GE VCT1700	MTIL6342
GE VCT 2000	MTIL6343
GE HiSpeed	MTIL6341
Philips Brilliance	MTIL6440
Siemens Biograph	MTIL6042
Siemens Definition MPT Cradle	MTIL6045
Siemens Definition PHS 1 A/B Cradle	MTIL6044
Siemens Definition PHS 4	MTIL6046
Siemens Biograph mCT	MTIL6049
Siemens Somatom go. and X.cite (Vario2)	MTIL6048
Siemens Somatom go. and X.cite (VarioRT)	MTIL6047
Canon Aquilion (formerly Toshiba)	MTIL6540
Canon Aquilion One (formerly Toshiba)	MTIL6541

### LINAC COMPATIBILITY

Varian TrueBeam Package Includes 53.1" (134.9 cm) Rectangular Extension, Prodigy 2 Lok-Bar, End Plate for Varian (MTIL6612), TrueBeam Reference Device (MTIL6151), Reference Lok-Bar, Wall Storage Device and mounting hardware	MTIL6142*
Varian Exact couch for Clinac and Trilogy Systems	MTIL6140
Varian Exact couch for Clinac and Trilogy Systems with Protura	MTIL6141
Elekta	MTIL6240
Siemens TXT or Protura	MTIL6040

All part numbers include UCT LE Couchtop with 53.1" (134.9 cm) Rectangle Extension, Prodigy 2 Lok-Bar and Wall Storage Device (MTIL6100SU, holds one extension). Pedestal side only purchasing options are available. Please contact your sales representative for more information.  
For proton compatibility, see page 192

## Universal Couchtop 1 Piece

The Universal Couchtop 1 Piece is an ideal IGRT and SBRT solution with a uniform design and no junctions. This couchtop offers a dosimetrically matched couchtop for most major CT and LINAC models.

### CT COMPATIBILITY

GE Discovery ST	MTIL6321
GE Global 1700	MTIL6322
GE Global 2000	MTIL6323
GE HiSpeed	MTIL6320
Philips Brilliance	MTIL6420
Siemens Biograph	MTIL6022
Siemens Biograph mCT	MTIL6029
Siemens Definition PHS 1 A/B Cradle	MTIL6024
Siemens Definition PHS 4 Cradle	MTIL6026
Siemens Somatom Sensation	MTIL6023
Siemens Somatom go. and X.cite (Vario2)	MTIL6028
Siemens Somatom go. and X.cite (VarioRT)	MTIL6027
Canon Aquilion (formerly Toshiba)	MTIL6520
Canon Aquilion One (formerly Toshiba)	MTIL6521
FujiFilm FTC Embrace (Contact FujiFilm)	

### LINAC COMPATIBILITY

Varian Exact couch for Clinac and Trilogy Systems	MTIL6120
Varian Exact couch for Clinac and Trilogy Systems with Protura	MTIL6121
Elekta	MTIL6220
Siemens TxT or Protura	MTIL6020

\*Universal Couchtop Long Extensions have been validated on TrueBeam, VitalBeam & Edge. Legacy CIVCO RT positioning and immobilization devices have not been validated with TrueBeam, VitalBeam or Edge and Varian is not liable for use of these products. Universal Couchtop has not been validated on HyperArc™.

## Universal Couchtop Extension Options

### Rectangular Extensions

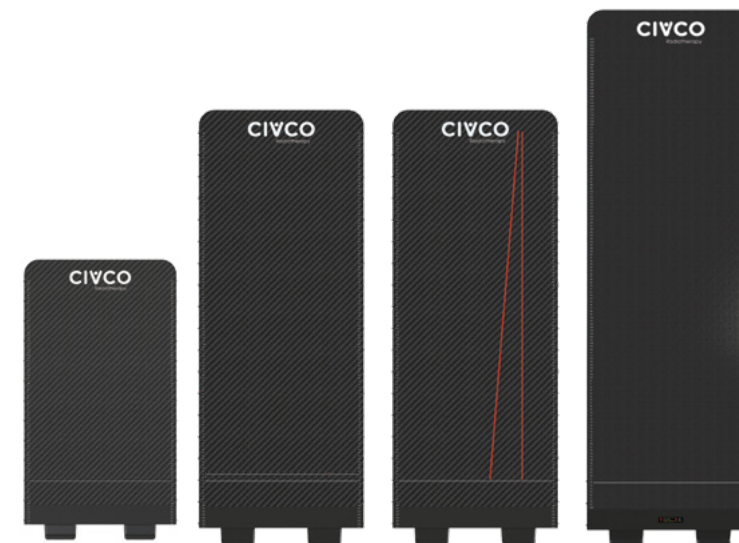

MTIL6669	36.6" (92.9 cm) Short Extension helps manage overall couchtop length when extending overlays past the end of the couch.
MTIL6660*	53.1" (134.9 cm) Standard Extension
MTIL6661*	53.1" (134.9 cm) Extension w/ embedded wires (shown in red) provides additional verification to ensure the patient is correctly aligned under LINAC isocenter relative to table position.
MTIL6676	64.9" (164.8 cm) Extension, CT
MTIL6673	64.9" (164.8 cm) Extension See page 192

### Body Pro-Lok ONE™

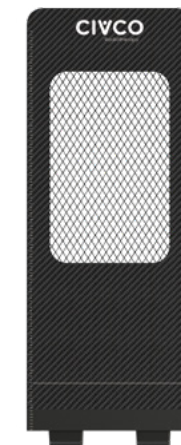

### Grid Extension

Helps minimize surface dose and skin reactions.

MTIL6663*	53.1" (134.9 cm)
-----------	------------------

\*Universal Couchtop Long Extensions have been validated on TrueBeam, VitalBeam & Edge. Legacy CIVCO RT positioning and immobilization devices have not been validated with TrueBeam, VitalBeam or Edge and Varian is not liable for use of these products. Universal Couchtop has not been validated on HyperArc.



## Universal Couchtop Extension Options

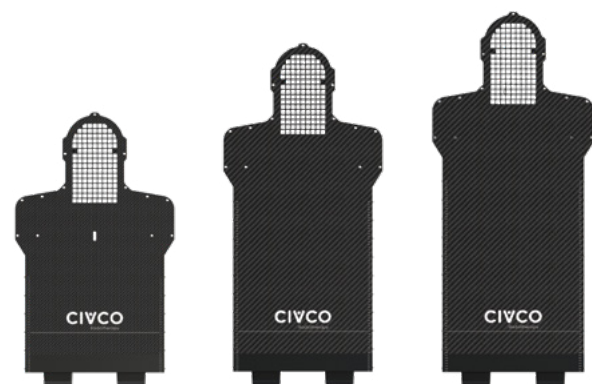

### Type-S Extensions

Allows for direct attachment of Solstice SRS and Solstat Immobilization Systems and all Type-S Thermoplastics, including the ClearVision open face mask designed for use with vision/camera systems.

49.1" and 53.1" Extensions do not have a central Vac-Lok point, therefore provides a larger unobstructed treatment region.

MTIL6665	39.1" (99.3 cm)
MTIL6670*	49.1" (124.7 cm)
MTIL6664	53.1" (134.9 cm)

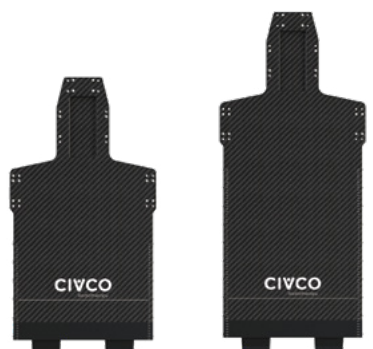

### Posifix Extensions

Allows for direct attachment of Solstice SRS and Solstat Immobilization Systems and Posifix Thermoplastics.

MTIL6666	39.1" (99.3 cm)
MTIL6672*	49.1" (124.7 cm)



Allows for direct attachment of trUpoint ARCH SRS/SRT System, Solstice SRS and Solstat Immobilization Systems and Posifix Thermoplastics.

MTIL6668	39.1" (99.3 cm)
MTIL6671*	49.1" (124.7 cm)

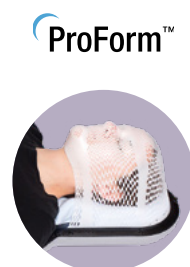

### ProForm Extension

Designed for the unique requirements of proton therapy. May also be used for photon treatment.

Additional lengths available, see page 193.

MTIL6675K	53.9" (136.9 cm), includes cushion forming guide and patient handles
MTIL6682K	Pediatric, 48.7" (123.7 cm), includes cushion forming guide and patient handles

\*Universal Couchtop Long Extensions have been validated on TrueBeam, VitalBeam & Edge. Legacy CIVCO RT positioning and immobilization devices have not been validated with TrueBeam, VitalBeam or Edge and Varian is not liable for use of these products. Universal Couchtop has not been validated on HyperArc.

## kVue™ Couchtops & CT Overlays

### KVUE THE BEST OF BOTH WORLDS

One couchtop, multiple treatment solutions, the kVue is a state-of-the-art radiotherapy couchtop optimized for the most recent advances in technology to guide your patient from simulation through treatment. The kVue CT Overlay accepts the same inserts as the kVue Couchtop. This provides the potential for more accurate dose planning and delivery (AAPM TG176).

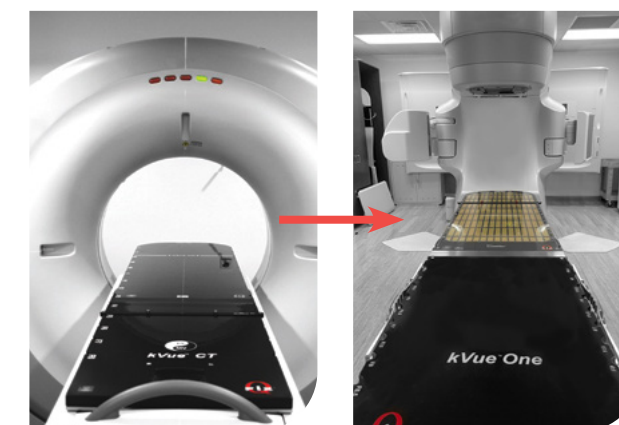

### ONETOUCH™ LATCH

Designed and rigorously tested for precision attachment to a variety of kVue inserts. It allows secure attachment and quick detachment with kVue inserts.

Validated with kVue inserts

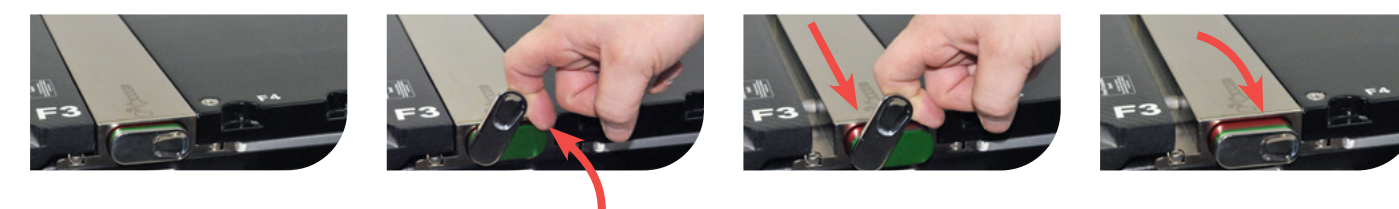

# kVue One Couchtop

The kVue One Couchtop is a one-piece modular design with a homogeneous composite base and no moving rails. It offers the ability to interchange treatment specific kVue inserts that mount directly into the top surface of the couch through the One Touch Latch. The light weight kVue One is compatible with versions of 6 Degrees of Freedom (DOF) linear accelerators and robotic bases. (5 mm WET without kVue Insert)

**RT-4551KV-01** kVue One Couchtop Base Frame without moving rails (Back Panel included. Requires an insert to function.)



OneTouch Latch

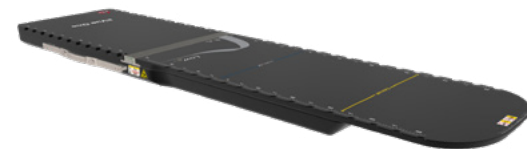

kVue One Couchtop (shown with RT-4551KV19 kVue Low-e Insert)

# kVue Couchtop

- Easily adapts to patient and treatment specific needs through the use of interchangeable kVue Inserts
- Inserts mount directly to the couchtop through the OneTouch Latch
- Moving rails can be moved laterally and independently according to treatment plan and imaging requirements

**RT-4551KV** kVue IGRT Couchtop Base Frame with moving rails (requires an insert to function)

**RT-4551KVO** kVue Indexing Back Panel with Varian Exact compatible indexing (not pictured)

**RT-4551KVA-ELK** Interface plate for Elekta, required for Elekta Couch installations (not pictured)

**RT-4551KVVHRD** Hardware Kit for Varian Exact Couch, required for Varian Exact installations

**RT-4551KVTBHRD** Hardware Kit for Varian TrueBeam Pedestal

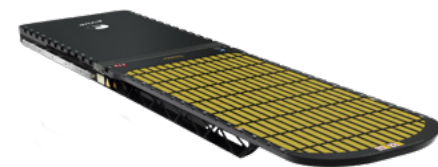
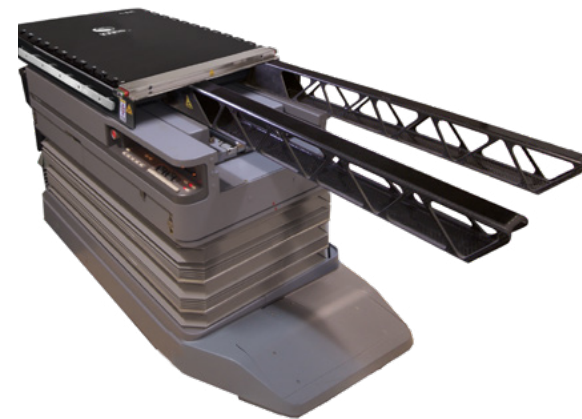

kVue Couchtop (shown with RT-4551KV18 kVue DoseMax Insert)

# kVue Insert Options

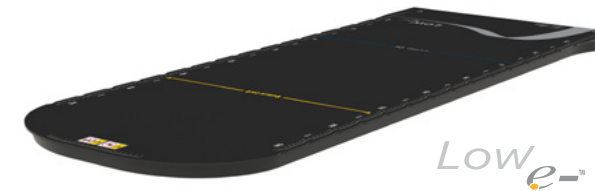

Low-e

## kVue™ Low-e™ Insert

A low electron generating, homogeneous insert for enhanced imaging and treatment. It is the optimal choice for a wide range of radiotherapy treatments.

Length: 1325 mm  
Water Equivalence: 4.2 mm @ 6 MV  
Weight Limit: 249 kg (550 lb) Uniformly Distributed Load

**RT-4551KV19** Includes Calypso Compatible Locating Bar

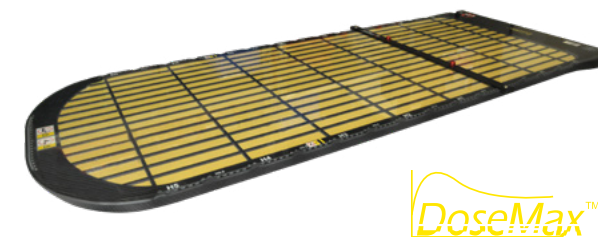

DoseMax

## kVue™ DoseMax™ Insert

Low electron generating insert combines the rigidity of a solid panel insert with skin-sparing properties comparable to a grid panel insert.

Length: 1325 mm  
Water Equivalence: 2.0 mm @ 6 MV  
Weight Limit: 249 kg (550 lb) Uniformly Distributed Load

**RT-4551KV18** Includes Locating Bar

**RT-4551KV5F** Replacement Film Skin for kVue DoseMax Insert - 3 pack

## kVue Short Insert

A shorter flat panel insert that allows the kVue to be retracted so that extended head and neck devices can be placed at isocenter.

**RT-4551KV2** Includes Locating Bar

## kVue 1610 mm Standard Insert

A versatile, homogeneous insert for enhanced imaging and treatment. It is the optimal choice for for proton therapy.

**RT-4551KV13** Includes Locating Bar

## kVue Universal Tip Insert

Allows mounting of quality assurance and treatment devices and provides universal mounting capability for some Varian Exact® style tip accessories.

**RT-4551KV8** Includes Locating Bar



## kVue Insert Options



### kVue Encompass SRS Insert

A highly specialized, non-invasive immobilization solution for stereotactic radiosurgery. Encompass is validated for use with Varian HyperArc. See page 61 for more information.

**RT-4600KV-01** Includes Encompass Headrest EO & Hand Grip Array



### kVue Portrait Intracranial, Head & Neck Insert

Provides superior immobilization for a variety of brain and head and neck radiotherapy treatments. See page 81 for more information.

Length: 1328 mm  
Water Equivalence: 6.0 mm @ 6 MV  
Weight Limit: 249 kg (550 lb) Uniformly Distributed Load

**RT-4552KV** Includes Locating Bar

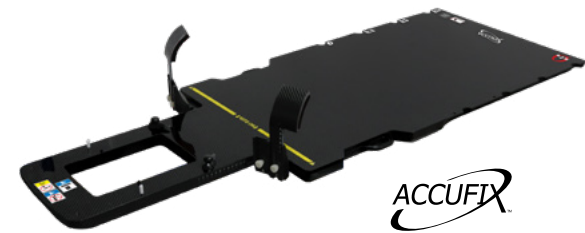

### kVue AccuFix Head & Neck Insert

Designed to immobilize the head, neck and shoulder regions. It is intended to provide optimum localization in the supine and prone positions.

Length: 1368 mm  
Weight Limit: 249 kg (550 lb) Uniformly Distributed Load

**RT-4525KVL** Includes Locating Bar



### kVue Bos Inserts

Specifically designed to meet the unique requirements of proton therapy for patient immobilization and beam transmission. It is engineered to rigidly support the patient without using a flat base that blocks the use of proton beam angles.

The conformal shape is designed to minimize the distance between the patient and the field defining aperture, optimizing the proton beam penumbra. See page 199 for more information.

**RT-4535KV** Standard Length (1320 mm) (top photo)

**RT-4535KV01** Shorter Length (1210 mm) (middle photo)

**RT-4535KV03** Longer Length (1580 mm) (bottom photo)

## kVue Access 360 G2 Prone Breast Insert

### NEAR 360 DEGREE TREATMENT ACCESS

Designed to allow breast cancer treatment for both left and right breast, including whole breast, partial breast and accelerated breast treatments. The sleek, cantilevered design provides both oblique and non-coplanar access, potentially enabling higher dose per fraction. Since the beam path is primarily through the breast with minimal couchtop interference, artifacts and scattering may be minimized.



### EXPANDED SUPRACLAVICULAR ACCESS

The thinner, wider grid window provides full access to treat the supraclavicular nodes. The supraclavicular access allows patient treatment in one setup if desired.



### kVue Access 360 G2 Package

**RT-4544KV-10** Includes Left & Right Inserts, Prone Headrest, Contour Headrest, 2 Hand Grip Posts, Dual Hand Grip, CT Risers, CT Shims, Storage Cart

**RT-4544KV** Access 360 G2 Treatment Room Extender Package (without CT Risers and Shims)

See page 158 for Prone Breast VacQfix Cushions



# kVue Virtual Indexing™

An array of white fiducial markers is placed down the center of the couch. The markers are located in line with the center of each indexing notch. A second array of fiducial markers are offset laterally to designate the superior or inferior location of the markers in relation to the indexing origin. This makes it easy to identify the indexing location on your image.

- Quickly ensures treatment couch is in the same position as the simulation couch—every time
- Enables more accurate and faster workflows
- Virtual Indexing is available on most couchtops, CT overlays, and many devices

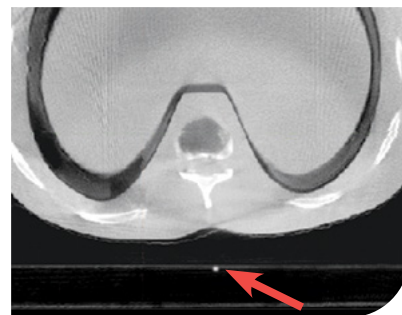

Works with most X-ray techniques such as cone beam CT

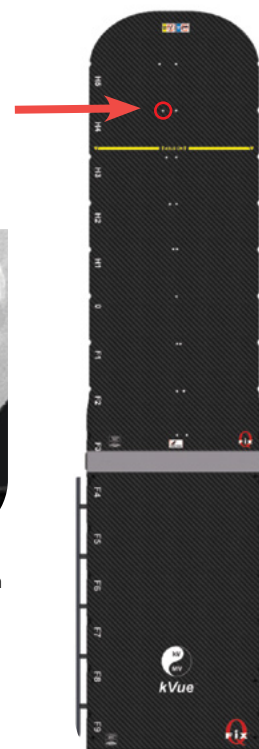

## KVUE CT OVERLAY FOR

## PART #

### CANON (FORMERLY TOSHIBA)

Canon Aquilion CT Scanner (for 2150 mm long cradle)	RT-4550KVTAQ
Canon Aquilion Scanner (for 2440 mm long cradle)	RT-4550KVTAQ2

### GE

GE LightSpeed and HiSpeed CTi CT Scanners (for 2310 mm long cradle)	RT-4550KVGEL
GE LightSpeed RT CT Scanner (for 2070 mm long cradle)	RT-4550KVGER
GE LightSpeed VCT Scanner (for 2620 mm long cradle)	RT-4550KVGEC

### PHILIPS

Philips Spectral CT 7500 (for 2450 mm long cradle)	RT-4550KVPH01
Philips Brilliance CT Scanner (for 2500 mm long cradle)	RT-4550KVPBR
Phantom Holder for Philips	RT-4550KVPBRPM

### SIEMENS

Siemens SOMATOM Confidence, SOMATOM Drive and SOMATOM Edge Plus (MPT, MPT2n or Vario 2 Table)	RT-4550KVSS3
Siemens PHS1B or Vario RT Table	RT-4550KVSS4
Siemens Biograph	RT-4550KVSS5
Phantom Holder for Siemens	RT-4550KVSSPM

# QUANTUM™ CT Overlays

QUANTUM CT Overlay, a flat, indexed surface for RT simulation, offering precise positioning and Varian Exact Indexing. It is thin, lightweight, and narrower than most overlays, providing increased usable bore space. The carbon fiber skin and foam core construction ensure minimal artifacts and superior imaging quality.



## QUANTUM CT OVERLAY FOR

## PART #

### CANON (FORMERLY TOSHIBA)

Cartesion CT Cradle (for 2780 mm long cradle) Celesteion CT Cradle (for 2780 mm long cradle)	RT-4550CN01
Aquilion Scanner (for 2150 mm long cradle)	RT-4550TAQ
Aquilion Scanner (for 2440 mm long cradle)	RT-4550TAQ2

### FUJIFILM

FCT Embrace	RT-4550FE
-------------	-----------

### GE

HiSpeed (for 2190 mm long cradle)	RT-4550GEH
HiSpeed CTi (for 2310 mm long cradle)	RT-4550GEL
ProSpeed (for 2070 mm long cradle)	RT-4550GEP
LS VCT (for 2620 mm long cradle)	RT-4550GEC
LightSpeed RT (for 2070 mm long cradle)	RT-4550GER
GT1700 & NG2000V	RT-4550GER2

### PHILIPS

Brilliance (for 2500 mm long cradle)	RT-4550PBR
--------------------------------------	------------

### SIEMENS

SOMATOM Confidence SOMATOM Drive SOMATOM Edge Plus (MPT2n Table)	RT-4550SS3
SOMATOM Definition Edge SOMATOM Definition AS/AS Open SOMATOM Definition Edge Plus SOMATOM Confidence (PHS1B Table) SOMATOM go.Up (Vario RT Table)	RT-4550SS4
Biograph	RT-4550SEA

Call for more details. Lead times may vary.

# CT Overlays

Carbon fiber one piece overlays securely lock onto a cradle, providing a surface consistent with treatment couchtops. They are lightweight and durable, allowing them to be easily removed or reinserted for use on imaging machines.

- Made of carbon fiber with a foam core
- Two-pin Lok-Bars allow positioning devices to be indexed to couchtop (14 cm intervals)

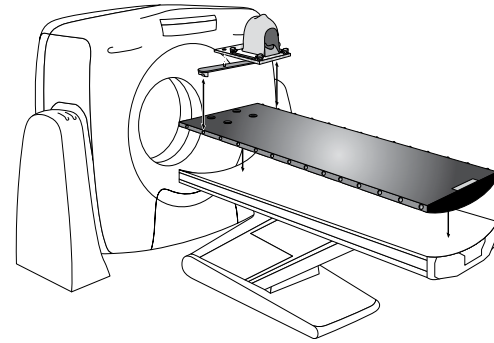

The following CT Overlay options are available; part numbers include 1 standard Lok-Bar:

CT OVERLAY FOR	PART #	INDEXING STYLE	COMPATIBLE LOK-BAR	COMPATIBLE TRANSVERSE LOK-BAR
<b>CANON (FORMERLY TOSHIBA)</b>				
Aquilion (Short)	MTIL3704	Interloc	MTIL3151	MTIL3152
Aquilion (Long)	MTIL3705	Interloc	MTIL3151	MTIL3152
<b>GE</b>				
HiSpeed Advantage, HiSpeed CT/i, LightSpeed QX/i	MTIL3300	Interloc	MTIL3151	MTIL3152
Discovery ST (H-Power Base)	MTIL3310	Interloc	MTIL3151	MTIL3152
LightSpeed VCT Discovery ST (Global Base)	MTIL3311	Prodigy	MTIL3653	MTIL3652
<b>PHILIPS</b>				
Gemini PET/CT	MTIL3404	Interloc	MTIL3151	MTIL3152
<b>SIEMENS</b>				
SOMATOM Sensation (after Aug 2004)	MTIL3013	Prodigy	MTIL3653	MTIL3652
SOMATOM Definition (PHS4 cradle)	MTIL3019	Prodigy	MTIL3653	MTIL3652
SOMATOM Definition, Emotion, Spirit, Perspective (PHS 1A or 1B cradle)	MTIL3020	Prodigy	MTIL3653	MTIL3652
Biograph	MTIL4101	Interloc	MTIL3151	MTIL3152

For MR Overlay options, see page 183.

# Lok-Bars™



## Prodigy™ 2 Lok-Bar

The Prodigy 2 Lok-Bar with 7 cm spacing is for use with all Universal Couchtops.

MTIL6050	Standard
MTIL6053	Fiberglass (recommended for use with UCT LE Kevlar Extension)
MTIL6051	Transverse (allow for offsetting patient laterally on the couchtop)
MTIL6054	MR, Three-Pin



## Prodigy Lok-Bar

The Prodigy Lok-Bar with 14 cm spacing is for use with Prodigy style indexed couchtops. The Slim Prodigy Lok-Bar features smaller side profiles.

MTIL3651	for 50 cm wide couchtop
MTIL3653	Slim Prodigy for 53 cm wide couchtop



## Interloc® Lok-Bar

The Interloc Lok-Bar with 14 cm spacing is for use with Interloc style indexed couchtops.

MTIL3350	for 48 cm wide couchtop
MTIL3051	for 49.5 cm wide couchtop
MTIL3850	for 50 cm wide couchtop
MTIL3151	for 53 cm wide couchtop



## Exact® Lok-Bar

The Exact Lok-Bar with 14 cm spacing is for use with Exact or Interloc style indexed couchtops.

20VARSUB10	for 53 cm wide couchtop
------------	-------------------------



# Lok-Bars



## Transverse Lok-Bar

The Transverse Lok-Bar allows for lateral movement of the two-pin system across the couchtop, providing more options in positioning the patient on the couchtop. The Transverse Lok-Bar is available in Prodigy, Prodigy 2, Interloc, PinnPoint™, Exact and Medical Intelligence indexing styles.

MTIL3152	Interloc, 53 cm
MTVAR46	Exact, 53 cm
MTIL3652	Prodigy, 53 cm
MTIL6051	Prodigy 2, 53 cm
MTIL3950	Medical Intelligence

## Slide Guide Lok-Bar

The Slide Guide Lok-Bar does not lock down to the indexing points along the couchtop but slides longitudinally along the couchtop. It is designed to prevent lateral movement and is useful for longer devices such as bellyboards, breastboards and Vac-Lok Cushions, which contract during forming.

MTVL00853	Standard, 40-53 cm
MTIL1006	Transverse, 48-53 cm

## Slide Guide Three-Pin Lok-Bar

The Slide Guide Three-Pin Lok-Bar slides longitudinally along the Universal Couchtop profile without being limited to any indexing points. It is designed to prevent lateral movement and is useful for longer devices such as bellyboards, breastboards and Vac-Lok Cushions, which contract during forming.

MTIL6058	Prodigy 2, 53 cm, MR Safe
----------	---------------------------

## Three-Pin Lok-Bar

Three-Pin Lok-Bars allow you to index MRI compatible devices to your MRI couchtop. They also help prevent non-MRI compatible devices from being used on an MRI machine.

See pages 180-188 for MRSeries.

MTIL3351	Interloc 50 cm
MTIL3352	Interloc 53 cm
MTIL3454	Prodigy 50 cm
MTIL6054	Prodigy 2, 53 cm
MTULB001	Elekta Unity MR-LINAC

# Locating Bars



## Locating Bar

Compatible with Varian Exact Style Indexing.

RT-4551BAR
------------



## MR Safe Locating Bar

Compatible with Varian Exact Style Indexing. See pages 180 - 188 for MRSeries.

RT-4551BARMRI
---------------



## Locking Locating Bar

Compatible with Varian Exact Style Indexing.

RT-4551BAR-05
---------------



## Transverse Locating Bar (Sliding)

The two indexing pins can be offset by 100 mm either left or right for increased flexibility of positioning an immobilization device and accessory setup, which is ideal for breast and SBRT treatment setups. They are compatible with CT Overlays and treatment couchtops with Varian Style Indexing.

RT-4551BAR-01
---------------



## Calypso Compatible Locating Bar

RT-4551BAR-02
---------------



## QA Locating Bar

Compatible with Varian Geometric Phantom.

RT-4551BAR-03
---------------



## Elekta Style Locating Bar

Locating bar for Elekta style indexed couchtops.

RT-4551BAR-04
---------------

# SofTouch Couchtop Pads

## SofTouch Couchtop Pads

Supportive and comfortable for patients during a variety of radiotherapy procedures. They are available in multiple lengths and thicknesses.

RT-4488-06	1.9 x 43 x 61 cm
RT-4488-05	.6 x 43 x 61 cm
RT-4488-04	1.9 x 50 x 180 cm
RT-4488-03	.6 x 50 x 180 cm
RT-4488-02	1.9 x 50 x 100 cm
RT-4488-01	.6 x 50 x 100 cm

SofTouch Couchtop Pads have a 90-day warranty from date of purchase. Foam products will vary in size due to manufacturing, storage, and use conditions. They are intended for patient comfort purposes only. Dimensions are for reference only.



## kVue Accessories

### kVue Insert Docking Plate

Provides greater flexibility for standardizing the use of kVue Inserts in multiple modalities. kVue Inserts can now be securely indexed to a wider variety of CT scanner and treatment couchtops through the use of this docking plate and two pin locating bars.



RT-4550KVQ

### Couchtop Service Panel

Mounts on any kVue Couchtop or couchtop with Varian Style Indexing to protect the couchtop surface during service or maintenance. This product is transparent.

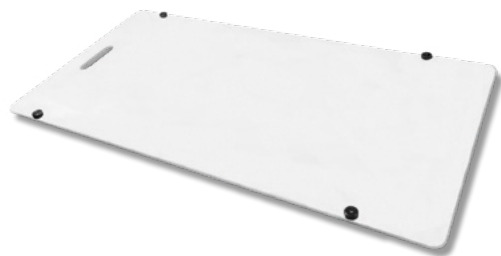

RT-4551SRV

# Universal Couchtop Accessories

## Patient Handles

Clamp to the Universal Couchtop, providing a stable place for immobilized patients to place their hands.



MTIL662501 Right handle

MTIL662502 Left handle

## UCT Head Extension

Secures to any UCT via a Prodigy 2 Lok-Bar allowing an additional 17 cm of treatment area.



MTIL6617

## Varian MPC IsoCal Phantom Mount

MTIL6152 Compatible with software version 2.7 and 3.0

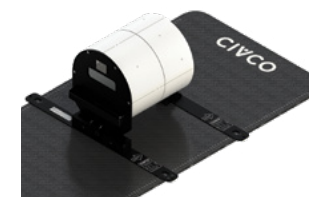

## End Plates for Varian

Allows for use of QA devices

MTIL6667 Interface Extension (attaches to UCT LE junction, left photo)  
Compatible with MTIL6140, MTIL6141

MTIL6612 Interface Sleeve (slides onto end of Rectangular Extensions, excluding Grid, right photo)  
Compatible with MTIL6140, MTIL6141, MTIL6142, MTIL6120, MTIL6121



## Foot Extension

A simple foot extension is available to maximize range for feet-first scans. The extension allows the patient's feet to extend up to 36 cm off the end of the table. The Foot Extension is designed for feet-first CT applications and is not suitable for use as a head extension.



MTIL3006002 Foot Extension, Prodigy

A yellow hard hat is centered in the background of the advertisement. It is a standard safety helmet with a chin strap and ventilation holes.

**FACT:**

Healthcare workers suffer more injuries on the job than construction workers.\*

That was the inspiration for creating our **Symphony® AirShuttle™ with AirDrive™ patient transfer system**. With minimal staff and effort, a patient can be safely transferred from one treatment, procedure, or imaging surface to another without having to reposition the patient. We think that's a pretty smart way to take care of all involved.

 **CQ MEDICAL™**  
Care Smarter  
Formerly CIVCO RT™ and Qfix®



# Symphony<sup>®</sup> Imaging, Treatment & Transfer Solution



## Symphony Solutions AirShuttle & AirDrive Options



A Symphony solution combines an AirShuttle patient platform with an AirDrive system to provide smooth patient transfers for imaging and treatment applications. AirShuttles and AirDrives can be used in imaging modalities including CT, X-Ray, ultrasound, fluoroscopy, MRI (up to 3 Tesla), and radiation therapy treatment environments including brachytherapy.

- Safely transfer your patient with minimal clinical staff
- Transfer on and off a wide variety of surfaces including sheet-covered pads and mattresses
- Patient positioning can include immobilization, where required
- Suitable for use in MRI

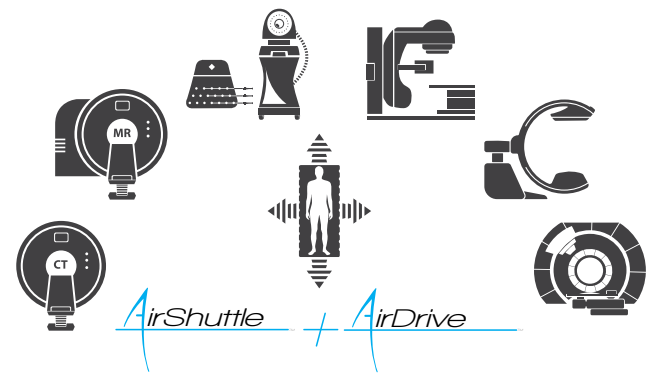

*Symphony*

*AirShuttle*

*AirDrive*

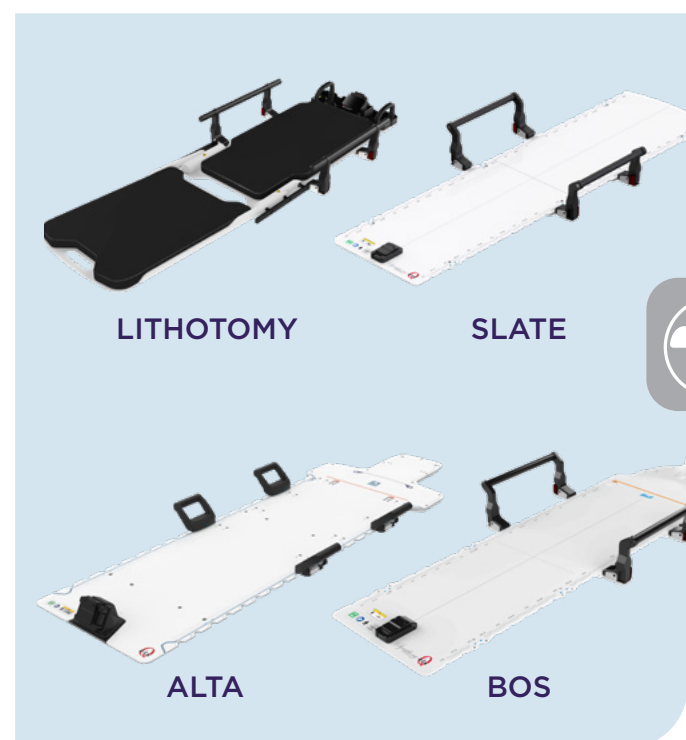

# Lithotomy AirShuttle

## MAXIMIZE WORKFLOW FLEXIBILITY

The patient is positioned once on the Lithotomy AirShuttle prior to insertion and then transferred easily, safely, and comfortably for imaging, treatment, and recovery.

- Integrated surgical rails are compatible with CT and MR imaging and allow stirrups, steppers, and other accessories to be quickly attached
- The leg extension supports the patient's legs for transfers and imaging and is easily removed to provide access to the perineum
- Provides stable patient support and reduced patient motion during transfers
- Clinicians report reduced applicator motion and improved patient comfort when using AirDrive technology over conventional patient transfers
- Patient transfers are performed with only two people, reducing staffing needs and allowing team members to focus on other responsibilities
- Removable, cleanable pads on the transfer device provide patient comfort from insertion through treatment
- Transfers laterally and longitudinally

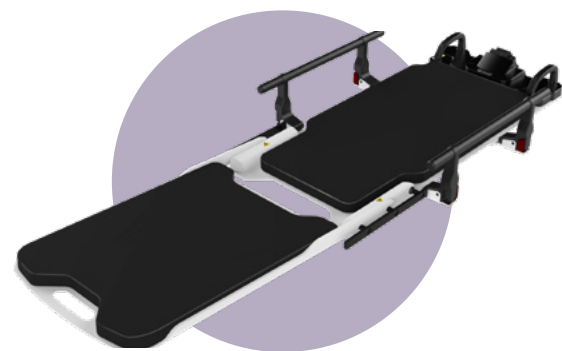

Lithotomy AirShuttle with AirDrive Caddie

## INSERTION CAN BE PERFORMED DIRECTLY ON TROLLEY



Lithotomy AirShuttle with AirDrive Trolley

### Lithotomy AirShuttle Packages

RT-5100-500	w/ AirDrive Trolley. Includes AirShuttle Transfer Handles (x2), Brachytherapy Insertion Overlay, Lithotomy Air Bearing (Spare), IV Pole
RT-5100-500S	w/ AirDrive Caddie. Includes: AirShuttle Transfer Handles (x2), Lithotomy Air Bearing (Spare)

# Brachytherapy Workflow

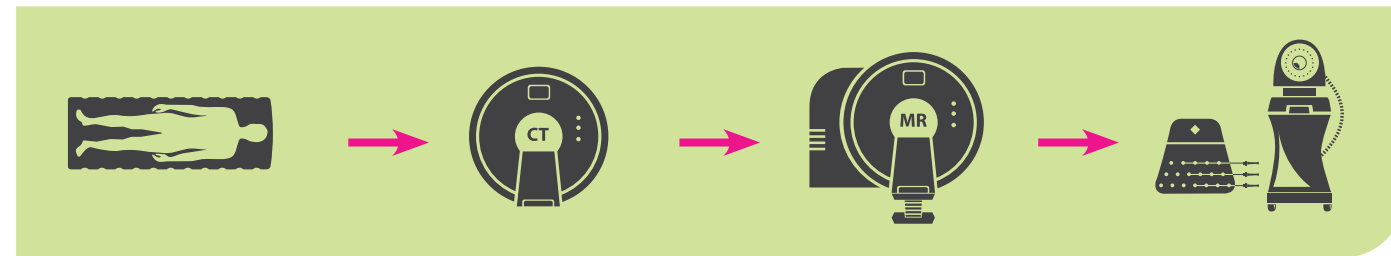

## Lithotomy Accessories



### Stirrups and SpringLoc Clamp

RT-5100-51ST	Stirrups (pair)
RT-5100-51CU	SpringLoc Clamp, US (each)
RT-5100-51CE	SpringLoc Clamp, Europe (each)

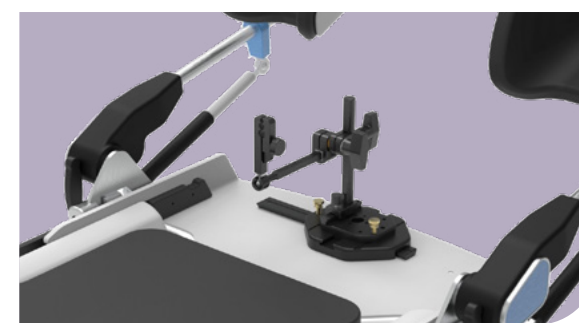

Applicator Clamp not included



### Applicator Clamp Holder

The Symphony Applicator Clamp Holder provides a safe and effective integrated solution to reduce applicator movement post-insertion. Post mounted or rail mounted versions accommodate various brachytherapy positioning workflows. Both holders are compatible with a wide variety of commercially available brachytherapy applicators. Compatible with CT and MR imaging.

RT-5100-53	Post Mounted Applicator Clamp Holder (left photo)
RT-5100-52	Rail Mounted Applicator Clamp Holder (right photo)



# Alta AirShuttle

## ELEVATE YOUR WORKFLOW EFFICIENCIES TO A WHOLE NEW LEVEL

All in one solution can be used for a wide range of indications to reduce setup times.

- Combines functionality of multiple devices
- Can be extended beyond end of couchtop
- Dependable and reproducible
- Fast and efficient

### Alta AirShuttle Packages

Both packages include: Alta AirShuttle Transfer Handles (x4), Alta ArmShuttle Elite, Silverman Pin Adapter, InfinityLock Hand grips (x2), FlexLock Knee Support, FlexLock Foot Support, MR Safe Locating Bars (x2), AirShuttle Locating Bars (x2), Alta Air Bearing (Spare), Wall Mount

RT-5100-700 w/ AirDrive Trolley

RT-5100-700S w/ AirDrive Caddie

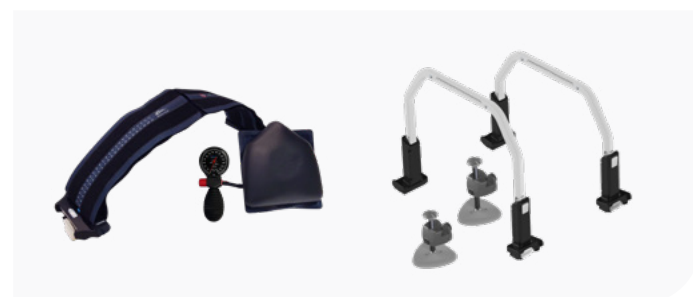
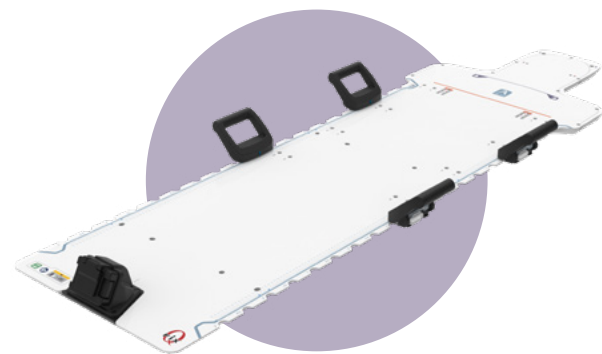

Example Accessories: ZIFix Traverse, InfinityLock Compression Bridges

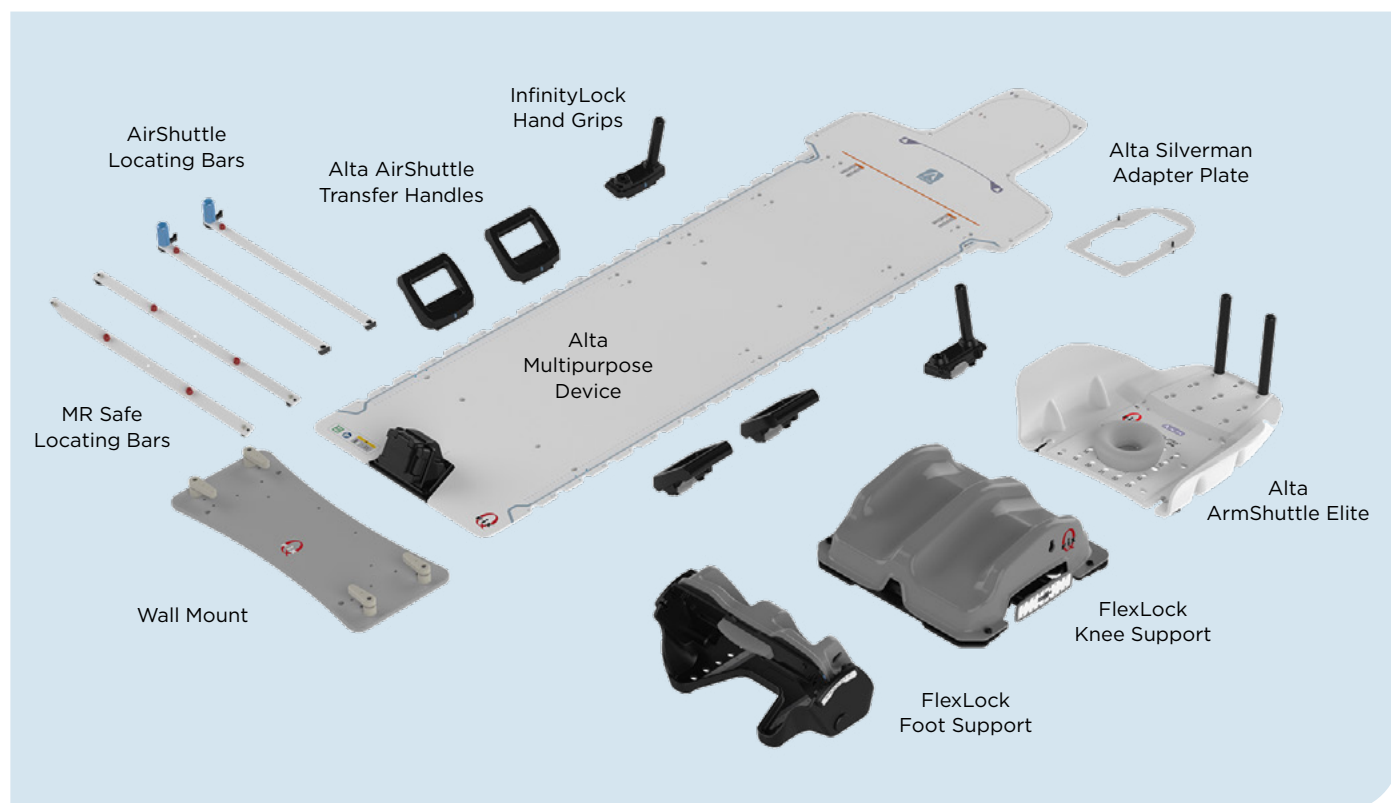

# Slate AirShuttle

## OUR THINNEST AND LIGHTEST AIRSHUTTLE

The Slate AirShuttle features low attenuation and homogeneity for enhanced imaging and treatment. It can be used in conjunction with existing positioning and immobilization devices, further improving workflow efficiencies.

### Slate AirShuttle Packages

Both packages include: AirShuttle Transfer Handles (x2), AirShuttle Locating Bars (x2), Slate Air Bearing (Spare)

RT-5100-100 w/ AirDrive Trolley

RT-5100-100S w/ AirDrive Caddie



Example Accessories: INSIGHT MRI Coil Holders, FlexLock Knee & Foot Supports, VacQfix Cushions, Locating Bars

# BoS AirShuttle

## DESIGNED FOR PROTON THERAPY

The conformal shape of the device optimizes the penumbra and minimizes the blockage of important proton beam angles.

### BoS AirShuttle Packages

Both packages include: AirShuttle Transfer Handles (x2), AirShuttle Locating Bars (x2), BoS Air Bearing (Spare)

RT-5100-400 w/ AirDrive Trolley

RT-5100-400S w/ AirDrive Caddie



Example Accessories: Foam Headrest, Precut Foam Shim for BoS Headframe, BoS Masks, Locating Bars

# Customized Cancer Care Workflow

- AirShuttle eliminates the need for patient repositioning between simulation and treatment
- Supports existing positioning & immobilization accessories and devices for lower cost of ownership
- Large, artifact-free, and homogeneous treatment area for precise dose delivery, including hypofractionation

## TOTAL BODY IRRADATION (TBI + VMAT)

- Provides rotational support, allowing a 180-degree patient orientation for both simulation and treatment procedures
- Enables the utilization of multi-isocenter treatment techniques
- Accommodates for patients up to 500 lbs.



## ADAPTIVE

- Allows consistent patient positioning from image acquisition through planning and treatment
- Enhances workflow efficiencies by streamlining processes
- Offers support for adaptation in offline, online, and real-time scenarios as required

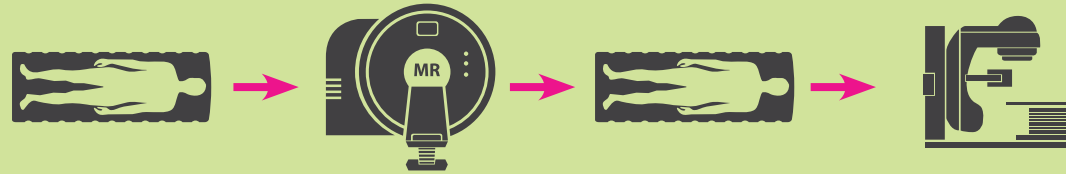

## MULTI-SIM

- Allows for a single patient setup that caters to both MR and CT simulations
- Facilitates patient setup and positioning outside of the simulation room
- Beneficial for patients with restricted mobility

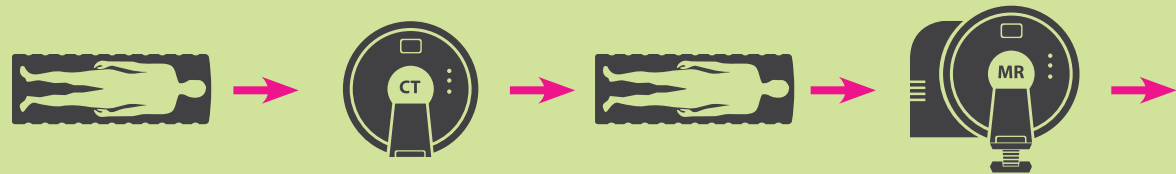

Alta on Halcyon™

## All in One Solutions

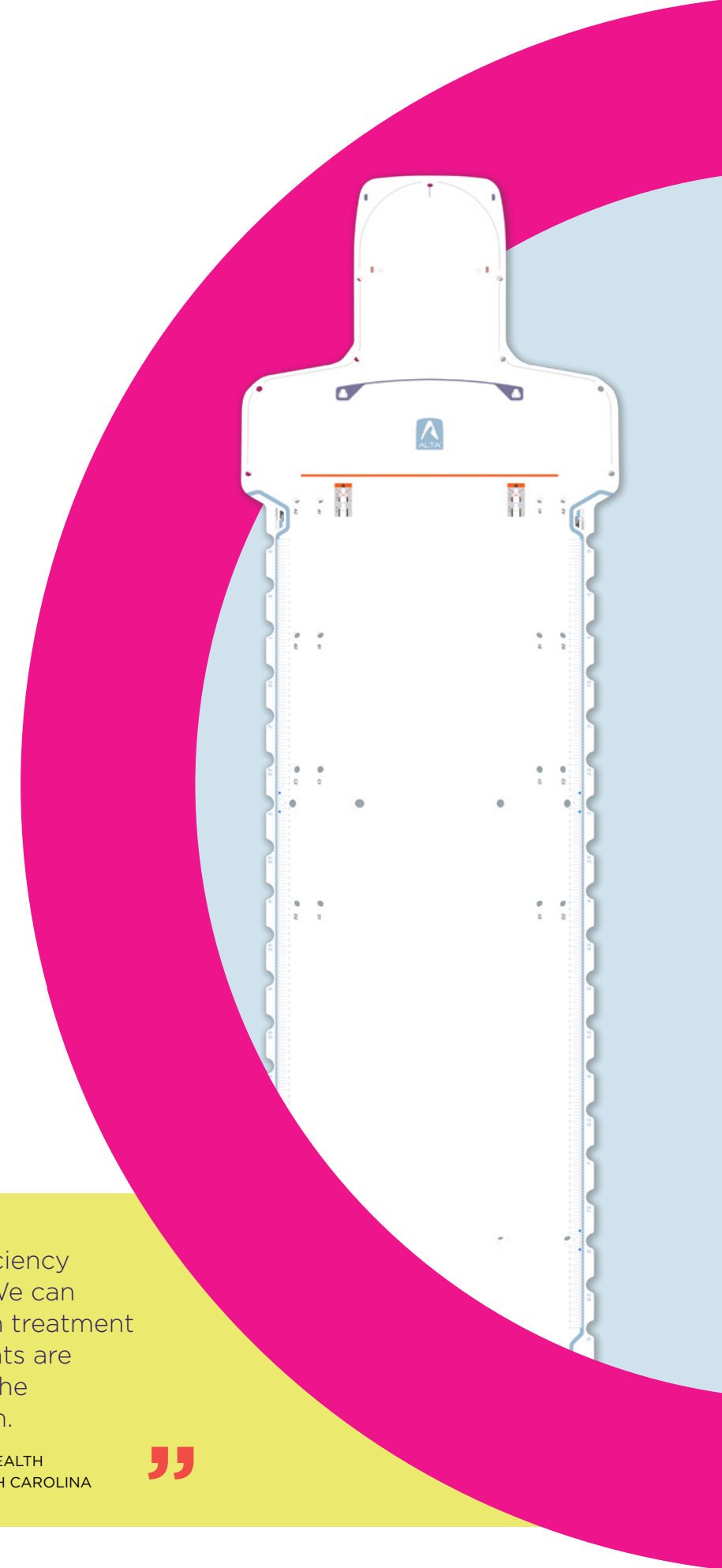

“

Alta has increased our efficiency between patient set ups. We can seamlessly switch between treatment types without delay. Patients are more satisfied and so are the therapists using the system.

CLINTON O'DELL BSRS RT(R)(T), ANMED HEALTH RADIATION ONCOLOGY ANDERSON, SOUTH CAROLINA

”

# Alta™ Multipurpose Device

Alta is an all in one solution that quickly adapts to a wide range of setups, reducing setup times.

- Combines functionality of multiple devices
- Dependable and reproducible
- Fast and efficient setups
- Can be extended beyond end of couchtop for improved head and neck dosimetry
- Lightweight-5.4 kg (12 lbs)
- 610 mm (24 in) W x 1990 mm (78.5 in) L
- MR Safe, CT, and treatment compatible

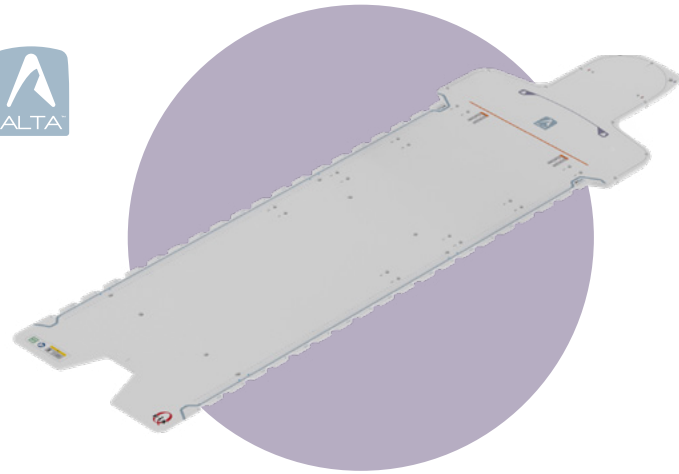

SRS



INTRACRANIAL, HEAD & NECK



CRANIOSPINAL



WHOLE BRAIN



BREAST



PELVIS



ABDOMEN



LUNG



THORAX



SBRT

# Elevate Your Workflow with Alta

## INFINITYEDGE™ & INFINITYLOCK™

InfinityLock accessories tightly fasten to the device and can be infinitely indexed along the InfinityEdge of the device.



## ALTA ARMSHUTTLE™ ELITE

Quickly and securely attaches to provide comfortable, reproducible positioning of the arms out of the treatment field.



## Alta Standard Package

Alta Multipurpose Device	Qty 1
Alta ArmShuttle Elite	1
Alta Silverman Adapter Plate	1
FlexLock Knee Support	1
FlexLock Foot Support	1
InfinityLock Hand Grips	2
MR Safe Locating Bars	2
Wall Mount	1
	<b>RT-4800-100</b>

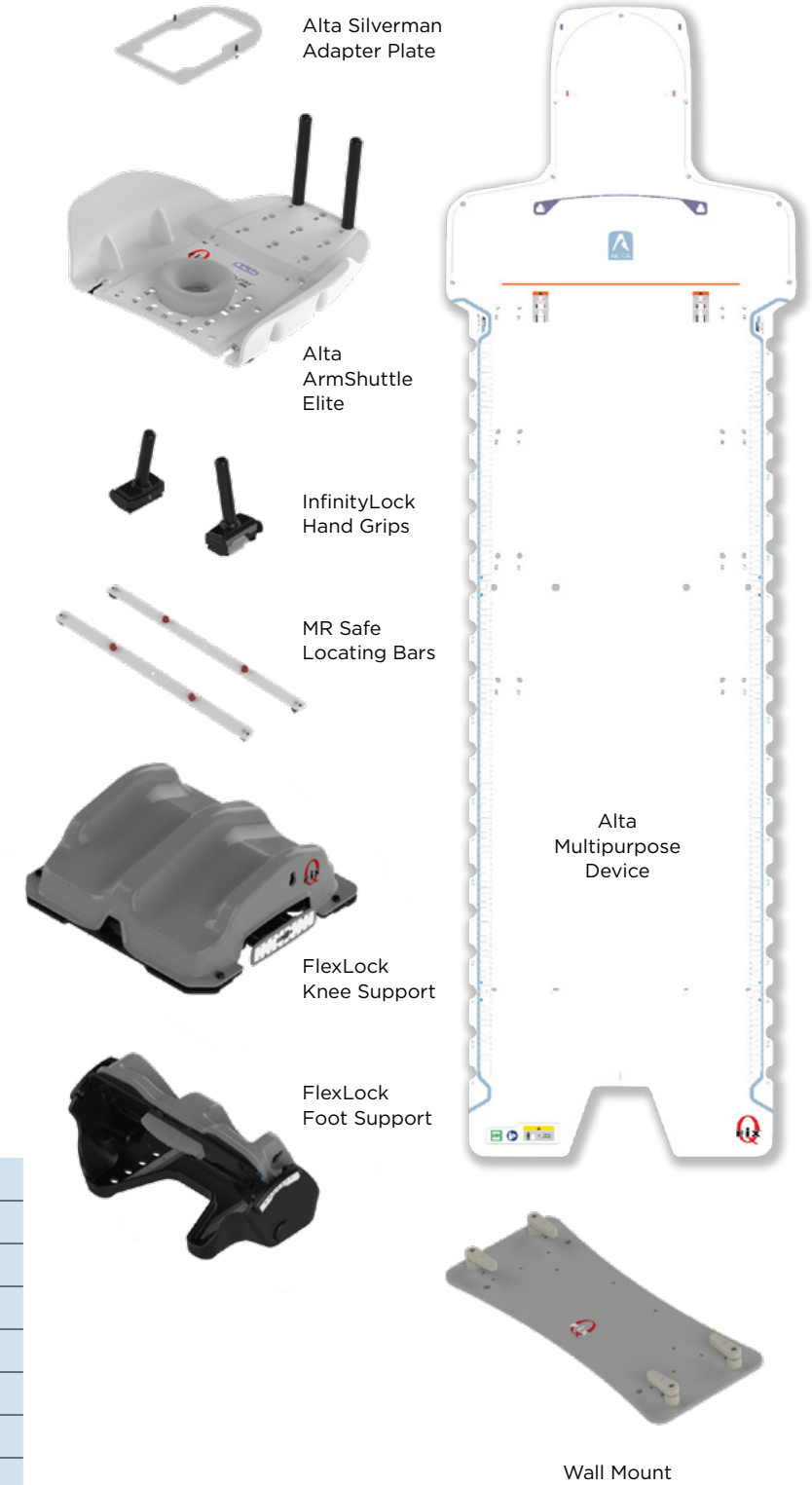



# Alta Integration

## FLEXIBILITY IN SRS, HEAD & NECK, CRANIOSPINAL, AND WHOLE BRAIN SETUPS

Alta can easily be used as a stereotactic radiotherapy treatment solution through the quick attachment of the SRS Adapter or Solstice SRS Immobilization System. Alta can extend beyond the couchtop to provide improved access to the head and neck region. It is compatible with Type-S thermoplastic masks, which can be directly attached to the device.

For the SRS Adapter, see page 66. For Type-S Head & Neck Solutions, see pages 82-88.



ENCOMPASS SRS



SOLSTICE SRS



HEAD & NECK



CRANIOSPINAL



WHOLE BRAIN

## SBRT IMMOBILIZATION

The low electron generating properties of Alta make it a great solution for stereotactic body radiation therapy setups. It can be adapted to apply abdominal compression when used with devices such as ZiFix Traverse or InfinityLock Compression Bridges.

For SBRT Solutions, see pages 51-54.



# TotalRT™ All in One Platform

## INCREASE EFFICIENCY, POSITION DEVICES EASILY AND GAIN CONFIDENCE IN PATIENT SETUP

The TotalRT All in One Platform is designed to quickly adapt positioning and immobilization solutions to your clinical setup and treatment needs. The platform is indexable on a couchtop, creating an affordable all in one solution and allowing seamless transition between patient treatments.



# TotalRT All in One Platform

- Easily indexable on CT, MR and photon treatment tables with two Lok-Bars
- Large, artifact-free and homogeneous treatment area for precise dose delivery, including hypofractionation
- Repeatable positioning of positioning and immobilization devices, even between treatment rooms
- A single therapist can carry and index to couchtop
- Wall storage device allows effective way to store and protect the platform
- Lightweight: 7.3 kg / 16 lbs
- Dimensions (cm): 201.3 (L) x 61.9 (W) x 3.5 (H)
- Platform is MR Safe

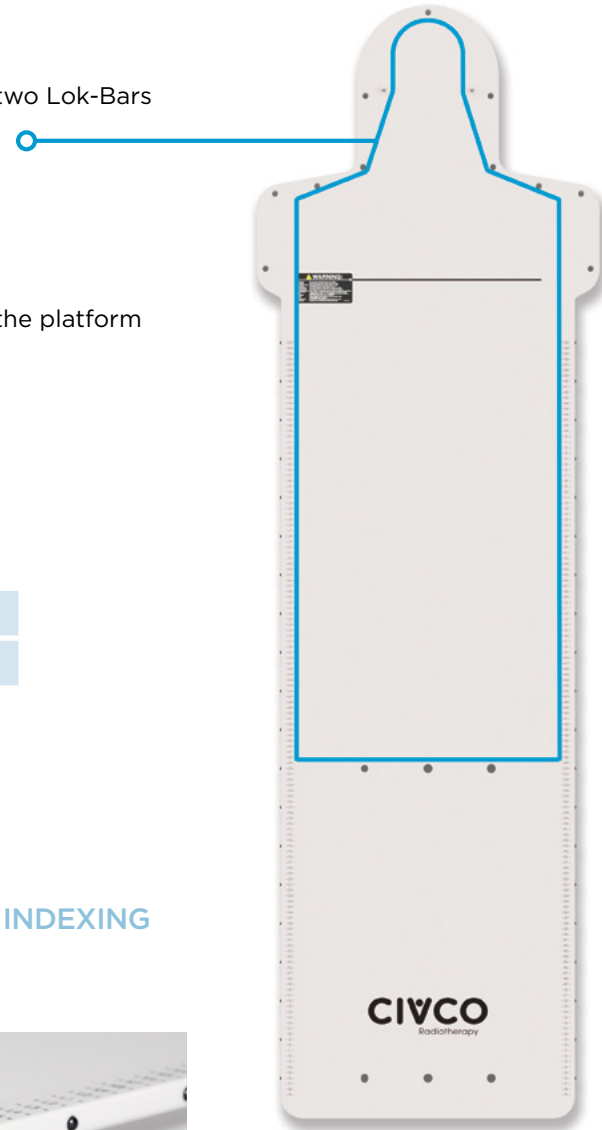

## TotalRT Platform

TRT100	201.3 cm, Glass Fiber
MTWBL001	Type-S Lok-Bar

### UNIVERSAL COUCHTOP PROFILE, PRODIGY 2 (7 CM) INDEXING

Directly attach devices to the platform or secure using Lok-Bars



### ALLOWS USE OF WING BOARDS IN HEAD & NECK AREA

Type-S Lok-Bar allows for indexing of any Three-Pin Wing Board or the Monarch Overhead Arm Positioner



## SBRT (STEREOTACTIC BODY RADIATION THERAPY)





# CHOOSING AN SBRT IMMOBILIZATION SYSTEM\*

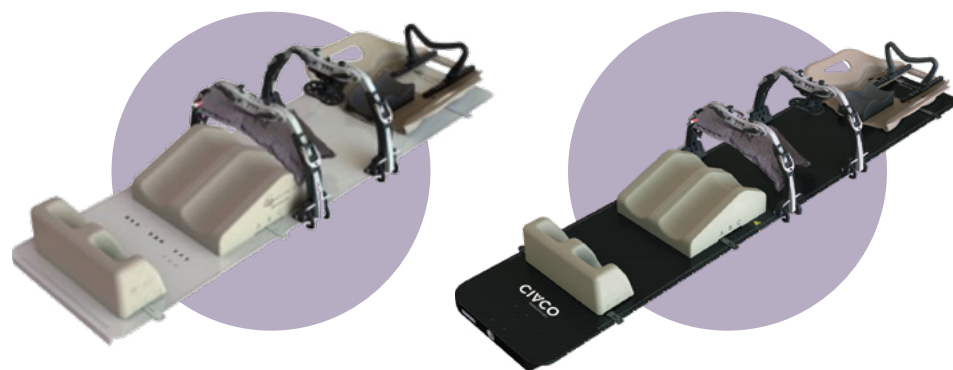

## Body Pro-Lok ONE™ Solution

Pages 44-50

<b>BRIDGE OPTION</b>	ONEBridge
<b>PLATE OR PADDLE OPTION</b>	Standard or Wide Plate w/ ComfortCare Cushion
<b>BELT OPTION</b>	ONE Respiratory Belt
<b>BRIDGE &amp; BELT INDEXING</b>	1 cm
<b>PLATFORM OPTION</b>	ONEPlatform (Length: 183 cm) TotalRT All in One Platform (Length: 201 cm)
<b>COUCHTOP (NO OVERLAY) OPTION</b>	Universal Couchtop or Elekta iBeam evo Couchtop with adapter
<b>MR OPTION</b>	Yes
<b>KNEES AND FEET POSITIONING</b>	Kneefix and Feetfix
<b>WING BOARD POSITIONING</b>	Monarch, Pro, Extended or Standard Wing Board
<b>VACUUM CUSHIONS</b>	Yes
<b>PATIENT HAND GRIP OPTION</b>	Yes
<b>INDEXABLE AND CUSTOMIZABLE DEVICES</b>	Yes

\*These SBRT devices offer many configurations and compatibilities. Please consult your sales representative for more information.

CONTACT SALES FOR  
BODY PRO-LOK™  
ORDERING INFORMATION

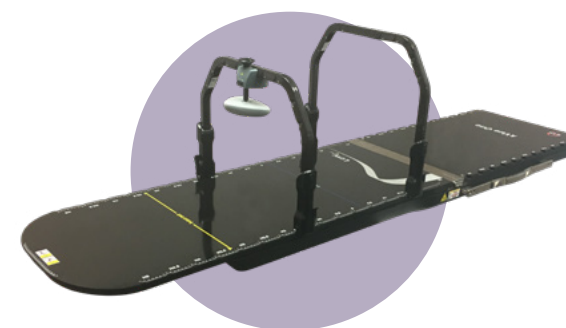

## kVue SBRT Solution

Page 55

kVue SBRT Bridges (two sizes)	InfinityLock SBRT Bridges (two sizes)
Standard or Low Profile Paddle	Standard or Low Profile Paddle
ZiFix Traverse	ZiFix Traverse
Infinite	Infinite
N/A	Alta Multipurpose Device (Length: 199 cm)
kVue Low-e Insert (Length: 132.5 cm)	N/A
No	Yes
FlexLock or Kneefix and Feetfix	FlexLock or Kneefix and Feetfix
ArmShuttle Elite	Alta ArmShuttle Elite
Yes	Yes
No	Yes
Yes	Yes



## Alta Multipurpose Device

Pages 51-54

# Body Pro-Lok ONE

The Body Pro-Lok ONE System provides one simple solution for complex SBRT patient setups. This system features the ONEBridge, with unique design features allowing for improved patient positioning and compression plate restriction.

## CUSTOMIZABLE & EFFICIENT

- Provides total body immobilization for hypo-fractionation treatments
- ONEPlatform provides seamless setup of patient from MR imaging/simulation to the LINAC unit
- Customized setups meet the patient's needs, including two options for reducing respiratory motion

## REPRODUCIBLE

- Components are indexable, allowing you to reproduce the same setup from day to day
- Immobilization above and below the patient are reproducible following published guidelines
- Setup sheet simplifies daily record keeping

Body Pro-Lok ONE™



“

We have become a referral center for SBRT patients and have employed Body Pro-Lok system for several years. It is my opinion that reproducible immobilization and abdominal compression is vital to assist in accurate targeting of lung cancers and other localized tumors. We recently upgraded our Body Pro-Lok system to the new Body Pro-Lok ONE and added a second complete system. We find it to be more flexible and efficient, especially with larger patients, without sacrificing the precision I demand.

RONALD C. MCGARRY, M.D., PH. D. UNIVERSITY OF KENTUCKY, LEXINGTON, KENTUCKY

”

# Improved Patient Positioning and Respiratory Restriction

The Body Pro-Lok ONEBridge is the only bridge on the market that features variable height adjustment along with lateral and tilting offset for varying body types. Two plate options are available for assisting in restricting respiratory movement: the Standard Respiratory Plate, or a Wide Respiratory Plate which can be coupled with a ComfortCare Cushion for additional customized comfort. A Respiratory Belt option is also available.

## ONEBridge™

- Variable height adjustment with just one bridge
- Lateral offset ability allows the bridge and plate to adapt to the patient's natural posture and body type
- Tilting offset ability allows optimal patient positioning for enhanced gantry clearance
- Advanced latch engineered to release in less than three seconds for patient safety



## Respiratory Plate & Respiratory Belt

- Respiratory Plates place pressure at the level of the diaphragm to assist in restricting respiratory movement.
- Respiratory Belts provide pneumatic compression and immobilization to the abdominal region for SBRT treatments.



## Wide Respiratory Plate with ComfortCare™ Cushion

- Wide Plate helps diffuse pressure across the abdominal region, resulting in a more comfortable compression for the patient
- ComfortCare Cushions, featuring innovative and patented technology by Pearl Technology AG, provides a new dimension of customized comfort at a reproducible pressure level.



For customization options, see pages 48-50.



Standard Respiratory Plate



ONE Respiratory Belt



Wide Respiratory Plate with ComfortCare Cushion

# Body Pro-Lok ONE Integration

## Universal Couchtop

Body Pro-Lok ONE positioning devices connect to the Universal Couchtop, allowing customized setups with bridges that secure directly to couchtop.

The Universal Couchtop is available for LINAC and CT, providing an environment in simulation that is reproducible and dosimetrically matched in treatment.

See pages 7-12 for details.



## ONEPlatform™

- Universal Couchtop profile and indexing options provide for seamless integration of positioning devices
- Indexing holes and Transverse Lok-Bar allow lateral offset of platform for optimal clearance
- Kevlar material is MR Safe
- Lightweight and 72" long

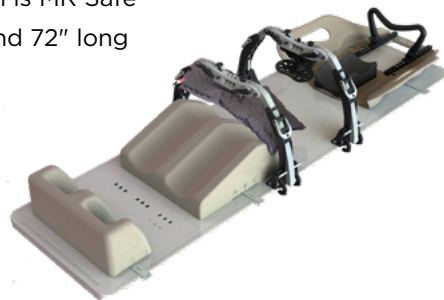

## Elekta iBEAM® evo Couchtop

- ONEBridge and ONE Respiratory Belt are compatible via a special adapter



ONEBridge w/ evo Adapter



ONE Respiratory Belt w/ evo Adapter

## COMPREHENSIVE ACCESSORY PACKAGES

	UCT	EVO
ONEBridge	Qty 2	Qty 2
ONEBridge Storage Base	2	2
Body Pro-Lok ONE Respiratory Belt	1	1
Wide Respiratory Plate w/ ComfortCare Cushion (x3) and Hand Pump	1	1
Clam-Lok Cushion	2	2
Kneefix 3 Cushion	1	1
Feetfix 3 Cushion	1	1
Monarch Overhead Arm Positioner	-	1
T-Shape Vac-Lok	-	1
Body Pro-Lok ONE evo Adapter	-	2 Pair
	<b>BPL150</b>	<b>BPL230</b>

## ONEPLATFORM PACKAGES

	GOLD	PLATINUM
ONEPlatform w/ four 3-pin Lok-Bars	Qty 1	Qty 1
ONEBridge	1	2
ONEBridge Storage Base	1	2
Body Pro-Lok ONE Respiratory Belt	1	1
Wide Respiratory Plate w/ ComfortCare Cushion (x3) and Hand Pump	1	1
Clam-Lok Cushion	2	2
Kneefix 3 Cushion	1	1
Feetfix 3 Cushion	-	1
	<b>BPL100</b>	<b>BPL110</b>
Body Pro-Lok ONE evo Adapter (in addition to all accessories above)	1 Pair	2 Pair
	<b>BPL200</b>	<b>BPL210</b>

# Body Pro-Lok ONE Integration

## TotalRT All in One Platform

- Body Pro-Lok ONE positioning devices connect to the TotalRT, allowing customized setups with bridges that secure directly to platform.
- The TotalRT Platform is easily indexable on CT, MR and photon treatment tables with two Lok-Bars.

See pages 39-40 for more details.

TotalRT packages are available. Contact your sales representative to learn more.

For customization options, see pages 48-50.



## Rails-Only System

The Body Pro-Lok ONE Rails-Only System provides compatibility of the Body Pro-Lok ONEBridge and ONE Respiratory Belt on IGRT couchtops and CT overlays with Varian Exact indexing when avoidance of an overlay or platform is preferred. Bridges and accessories are sold separately.

**BPL020** 53 cm, Varian Exact



## RESPIRATORY RESTRICTION PACKAGE

ONEBridge	Qty 1
ONEBridge Storage Base	1
ONE Respiratory Belt	1
Standard Respiratory Plate	1
BPL ONE Exact/IGRT Rails-Only	1
	<b>BPL300</b>



## SBRT Customization



### ONEBridge

Unique design features allow for improved patient positioning and compression plate restriction.

See page 45 for more details.

BPL001

### BRIDGE ACCESSORIES



### ONE Respiratory Belt

Provides pneumatic compression and immobilization to the abdominal region.

BPL026



### Standard Respiratory Plate

Places pressure at the level of the diaphragm to assist in restricting respiratory movement.

MTSBRT003



### Wide Respiratory Plate with ComfortCare Cushion

Helps diffuse pressure across the abdominal region while adding a dimension of customized comfort for the patient.

BPL120 Start up Kit (Wide Plate, 3 Cushions and Hand Pump)

BPL007 ComfortCare Cushions, Qty 3

BPL008 Wide Respiratory Plate

BPL009 Hand Pump



### Clam-Lok™ Cushion

Forms to comfortably enhance immobilization from above.

VLSBRT202FC



### Forehead Restraint

Attaches to the bridge and provides a padded restraint mechanism for the head.

MTSBRT018

### Body Pro-Lok ONE evo Adapter

Allows for 1 cm indexing of the ONEBridge and ONE Respiratory Belt to iBEAM evo Couchtops.

BPL010 1 Pair



## SBRT Customization



### ONEPlatform

Weight: 14.5 lbs (6.6 kg) Length: 72" (1829 mm)

See page 46 for more details.

BPL003



### TotalRT Platform

Weight: 16 lbs (7.3 kg) Length: 79.3" (2013 mm)

See pages 39-40 for more details.

TRT100



### Monarch Overhead Arm Positioner

Dual function hand grips allow for natural flexion of the patient's wrists while providing increased positioning options for the clinician.

See page 136 for additional Wing Board options.

OAP110



### T-Shape Vac-Lok

Provides arms-up positioning while cradling the torso region. May be used with the Monarch Overhead Arm Positioner or a Wing Board.

VL0017 Nylon w/ indexing, Tapered mid-section, 44L Fill

VL0018 Nylon w/ indexing, Non-Tapered mid-section, 42L Fill

VL0022 Nylon w/ indexing, Tapered mid-section and Handle Cut Out, 31L Fill

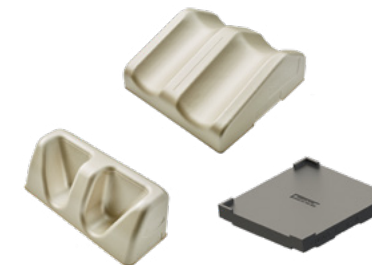

### Kneefix 3 & Feetfix 3 Cushions

Contributes to better stability, reproducibility and comfort in the supine position.

301052 Kneefix 3

301071 Feetfix 3

301055 Elevation Block

## SBRT Customization



### Patient Handles

Patient handles provide a stable place for immobilized patients to place their hands.

**MTIL662501** Right handle

**MTIL662502** Left handle



### Three-Pin Lok-Bar

Allows positioning devices to be fixed to the couchtop or platform for enhanced reproducibility.

**MTIL6054** Prodigy 2, 53 cm



### Slide Guide Lok-Bar

Ideal for Vac-Lok bags, the Lok-Bar slides longitudinally along the couchtop rather than locking down to indexing points.

**MTVL00853**



### Transverse Lok-Bar

Allows the 2-pin system to move laterally across the couchtop

**MTIL6051** Prodigy 2, 53 cm



### Prodigy 2 Lok-Bar

Allows positioning devices to be indexed to the Universal Couchtop and TotalRT Platform.

**MTIL6050**

## WING BOARDS & HEADRESTS

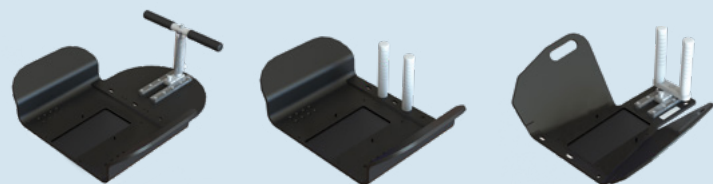

See page 136 for additional Wing Board options



See pages 109-114 for headrest options

## Alta™ Multipurpose Device

The low electron generating properties of Alta make it a great solution for stereotactic body radiation therapy (SBRT) setups. It is compatible with a variety of accessories to immobilize the patient, such as our 2 and 3-chamber VacQfix cushions and Alta ArmShuttle Elite. It can be adapted to apply abdominal compression when used with devices such as ZiFix, ZiFix Traverse, InfinityLock Compression Bridges and paddles. This setup is customizable for a wide range of patient anatomies while also ensuring patient comfort.

See pages 37-38 for information on Alta All in One Solution.



## Alta Compression Customization



### InfinityLock™ Bridges & Paddle

The InfinityLock Bridges attach to the edges of the Alta multipurpose device to help immobilize the patient and reduce organ motion.

RT-4800-B1	InfinityLock SBRT Compression Bridge, Small (min: 300 mm & max: 380 mm)
RT-4800-B2	InfinityLock SBRT Compression Bridge, Large (min: 390 mm & max: 480 mm)
RT-4558KV4	Compression Paddle, Standard
RT-4558KV4-01	Compression Paddle, Low Profile

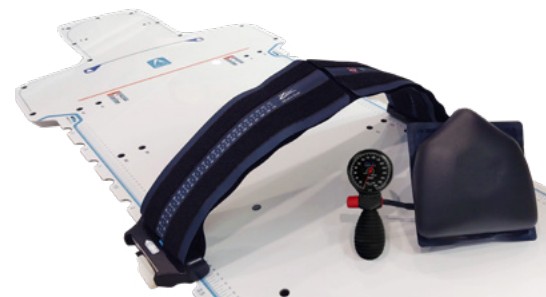

### ZiFix Traverse™ Abdominal/Thoracic Motion Control System

ZiFix Traverse attaches to the edges of the device to help immobilize the patient in addition to reducing organ motion.

- Low profile compression for most imaging and treatment systems
- Immobilizes patient during imaging and treatment
- Minimizes potential for collisions and interference when compared to compression bridge



130 mm x 1700 mm Belt	Qty 1
130 mm x 1300 mm Belt	1
Manometer Pump	1
130 mm Compression Paddle w/ Inflatable Bladder	1
Clamps	2
<b>RT-4558CB03</b>	



Fiducial markers aid in consistent patient setup relative to patient anatomy



Bladder is designed to be durable up to 250 mmHg, a 2x factor of safety



Features InfinityLock to quickly and securely attach to compatible CQ Medical devices

## Additional Alta, Low-e, and DoseMax SBRT Customization



### FlexLock Knee & Foot Supports

Provides customizable indexing options for positioning the lower abdomen, pelvis, and lower extremities. FlexLock Knee & Foot Supports are included in Alta Standard Package RT-4800-100. See page 144 for more information.

RT-4800-KS	FlexLock Knee Support
RT-4800-FS	FlexLock Foot Support



### ArmShuttle Elite

Provides many head & arm positioning options in a lightweight and ergonomic design. Alta ArmShuttle Elite is included in Alta Standard Package RT-4800-100.

RT-4546C	ArmShuttle Elite, 2-pin indexable
RT-4800-02	Alta ArmShuttle Elite



### VacQfix Cushions

Contoured positioning that custom forms to a specific patient for enhanced comfort and accuracy.

RT-4517-0002	2-Chamber cushion
RT-4517-0003	3-Chamber cushion



### Thigh Compression VacQfix Cushion

Complete leg immobilization with adjustable, snap-on attachment along compression bridge.

RT-4517-4079VF15
------------------



### VacQfix Indexer

Quick, easy vacuum indexing device that is adjustable for a variety of setups.

RT-4517-IND01
---------------



## Additional Alta, Low-e, and DoseMax SBRT Customization



### ZiFix Abdominal/Thoracic Motion Control System

ZiFix is an abdominal/thoracic motion control system that wraps around the patient to provide abdominal compression. It induces shallow breathing, reducing organ motion caused by respiration.

- Compatible with CT and MRI environments up to 3T
- Suppresses motion of lungs and liver for imaging and radiotherapy
- Provides positional consistency between imaging, simulation, and treatment
- Can be used as a standalone unit or with other SBRT products
- Couchtop Independent

200 mm x 1700 mm Belt	Qty 1
130 mm x 1700 mm Belt	1
130 mm x 1300 mm Belt	1
Manometer Pump	1
200 mm Compression Paddle w/ Inflatable Bladder	1
130 mm Compression Paddle w/ Inflatable Bladder	1
130 mm Buckle	1
200 mm Buckle	1
	<b>RT-4558CB02</b>

## kVue One Low-e Insert

The kVue Low-e insert is a low electron generating, homogeneous insert for enhanced imaging and treatment. It can be used in conjunction with the radiolucent kVue Compression Bridges for SBRT treatments, improving workflow efficiencies and eliminating the need for a separate SBRT device.

See pages 53-54 for Low-e SBRT customization.

- Used for a wide range of patient treatment setup
- Low water equivalence

<b>RT-4551KV19</b>	kVue Low-e Insert, 1325 mm
<b>RT-4558-B1</b>	kVue SBRT Bridge, Small
<b>RT-4558-B2</b>	kVue SBRT Bridge, Large
<b>RT-4558KV4</b>	Compression Paddle, Standard
<b>RT-4558KV4-01</b>	Compression Paddle, Low-Profile



kVue Low-e Insert shown with kVue SBRT Bridges and Compression Paddle

## kVue DoseMax Insert

Can be used with the radiolucent kVue Compression Bridges for stereotactic body radiotherapy (SBRT) treatments, improving workflow efficiencies and eliminating the need for a separate SBRT device.

See pages 53-54 for DoseMax accessories.

- Lowest attenuating couchtop surface
- Maximizes dose to the tumor, while minimizing dose to the skin
- Ideal solution for a range of radiotherapy indications from palliative treatment to SBRT

<b>RT-4551KV18</b>	kVue DoseMax Insert
<b>RT-4588-01</b>	DoseMax Standalone Device for Simulation
<b>RT-4558-B1</b>	kVue SBRT Bridge, Small
<b>RT-4558-B2</b>	kVue SBRT Bridge, Large
<b>RT-4558KV4</b>	Compression Paddle, Standard
<b>RT-4558KV4-01</b>	Compression Paddle, Low-Profile



kVue DoseMax Insert shown with kVue SBRT Bridges and Compression Paddle

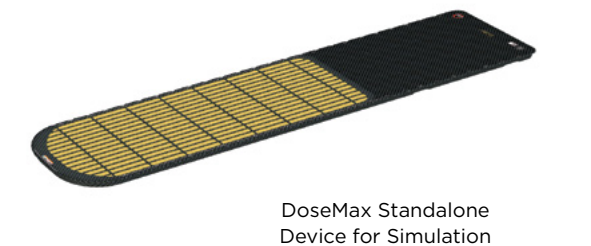

DoseMax Standalone Device for Simulation





# COMFORTABLE IMMOBILIZATION IS NOT AN OXYMORON

Not to us, anyway. We believe that comfort and the products that hold a patient in place during radiotherapy must coexist. When a patient is immobilized and comfortable, it puts them in a better position for better possible outcomes.

 **CQ MEDICAL™**  
Care Smarter  
Formerly CIVCO RT™ and Qfix®



# SRS/SRT (STEREOTACTIC RADIOSURGERY/ RADIOTHERAPY)



## CHOOSING AN SRS IMMOBILIZATION SYSTEM



### Encompass™ SRS Immobilization System

### Solstice™ SRS Immobilization System

Pages 60-62

Pages 63-65

HYPERARC™ VALIDATED	Yes	No
SGRT COMPATIBLE	Yes	Yes
MR SAFE OPTION	Yes	Yes
THERMOPLASTIC OPTIONS	Open Face	Open or Closed Face
THERMOPLASTIC FRAME SIZE	1 (Standard)	2 (Standard or Narrow)
MASK ATTACHMENT STYLE	Integrated Shim Pins	Thermoplastic Clips
POSTERIOR HEAD SUPPORT	Thermoplastic or Customizable Cushion	Customizable Cushion
SHIM OPTION	Integrated in Frame, 0.5 mm increments	AccuForm Shim
BITE POSITIONER	IntegraBite	Precise Bite
SHOULDER THERMOPLASTIC	No	Yes
CORRECTIVE PITCH CAPABILITY	No	Yes
EMBEDDED FIDUCIAL	Yes	No



# Encompass SRS Immobilization System

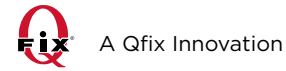

Highly rigid, non-invasive immobilization device designed for precisely targeted treatment to the brain, head & neck.

- Immobilization for treatment of multiple lesions with a single isocenter
- High-precision immobilization with submillimetric accuracy for stereotactic radiosurgery, including trigeminal neuralgia
- Integrated Shim System optimizes workflow efficiencies
- Open view thermoplastic can reduce patient anxiety and allows for intra-fraction positioning verification utilizing optical tracking systems
- Submillimetric immobilization with or without optional IntegraBite

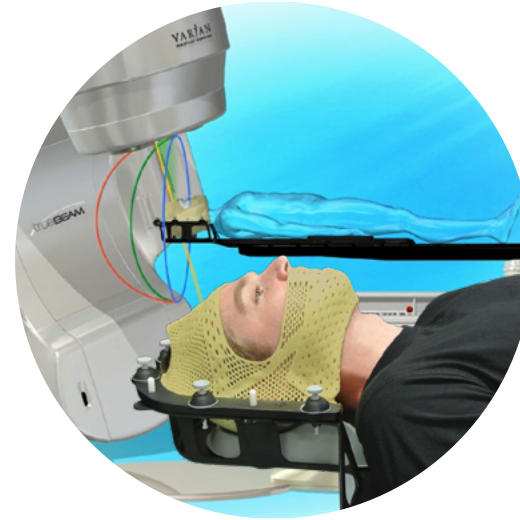

Validated for HyperArc. Image is used courtesy from Varian, a Siemens Healthineers company.

## Integrated Shim System

Innovative Integrated Shim allows independent height adjustment at each pin, providing completely customizable immobilization. Each Integrated Shim can be adjusted in discrete 0.5 mm increments, with a total range of 4 mm.

- Adjusting shim height is as easy as simply rotating the pin
- Eliminates the need for mask removal to adjust shim height
- Better workflow and instant setup feedback



## IntegraBite

- Decreased head and neck rotation, flexion, and extension
- Repeatable positioning
- Simple, streamlined design makes application and insertion easy

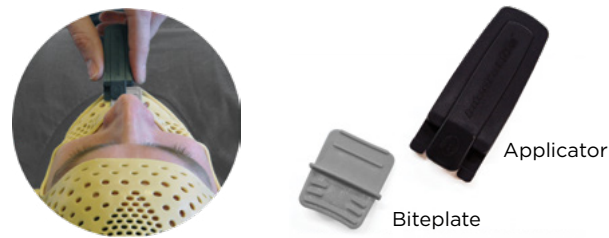

## Encompass SRS Fibreplast Masks

Made from the most rigid thermoplastic material available, providing anterior and posterior cranial support.



visionrt COMPATIBLE

# Encompass SRS Devices

## Encompass SRS Standalone Device

Device Length: 1358 mm  
 Handling Weight: 5.5 kg (12 lb)  
 Weight Limit: 249 kg (550 lb), Uniformly Distributed Load at maximum cantilever position indicated on device

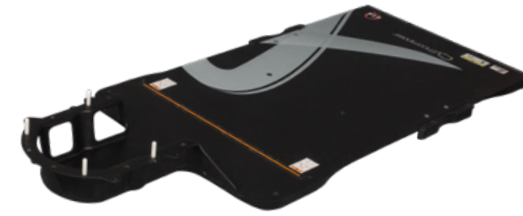

RT-4600-01

## kVue Encompass SRS Insert

Device Length: 1311 mm  
 Handling Weight: 4.5 kg (10 lb)  
 Weight Limit: 249 kg (550 lb), Uniformly Distributed Load at maximum cantilever position indicated on device



RT-4600KV-01

## Encompass SRS MR Standalone Device

Device Length: 1358 mm  
 Handling Weight: 5.5 kg (12 lb)  
 Weight Limit: 249 kg (550 lb), Uniformly Distributed Load at maximum cantilever position indicated on device



RT-4600-01-MRI

## Encompass SRS Standalone Device compatible with bridges

Device Length: 1358 mm  
 Handling Weight: 5 kg (11 lb)  
 Weight Limit: 249 kg (550 lb), Uniformly Distributed Load at maximum cantilever position indicated on device



RT-4600-02

# Encompass SRS Thermoplastic Options

## Thermoplastic Option 1

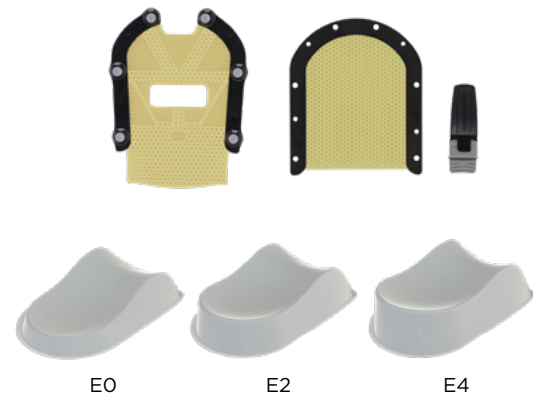

<b>RT-B889KYCF2*</b>	Encompass SRS Fibreplast System with Optional IntegraBite. Includes: Fibreplast Variable Perf Open View Mask, Posterior Thermoplastic, Optional IntegraBite See page 60 for more information
<b>RT-4600-10*</b>	E0 SRS Headrest (included with all Encompass devices)
<b>RT-4600-12**</b>	E2 SRS Headrest (included with SRS Adapter)
<b>RT-4600-14**</b>	E4 SRS Headrest (included with SRS Adapter)



## Thermoplastic Option 2

<b>RT-B889KYCF2A**</b>	Encompass SRS Anterior Only Fibreplast Mask to be used with SRS Cushion Support (includes AccuForm U Head Cushion, 200 mm x 350 mm)
<b>RT-4600-20**</b>	SRS Cushion Support (not included with Encompass or SRS Adapter)

\*Validated with HyperArc  
\*\*Safe to use with HyperArc

E0 SRS Headrest and Hand Grip Array included with all Encompass Devices.



Direct Indexing Adapters are available for indexing the standalone device to specific couptop models.



# Solstice SRS Immobilization System

The Solstice SRS Immobilization System provides unique corrective pitch capability and positioning flexibility for submillimeter accuracy to treat multiple lesions with a single isocenter. The system is comprised of a head support, customizable cushion and dedicated thermoplastic mask designed for secure and simple attachment. These components create a highly customizable and comfortable head and neck immobilization system for precise treatment to improve patient outcomes.

- Midline thermoplastic mask attachment provides increased rigidity and minimizes shrinkage to enhance patient comfort
- Highly conformal to the patient when using a customizable cushion and dedicated thermoplastic mask
- Unique thermoplastic frame provides easy to use, secure and quiet mask attachment
- Glass Fiber version is MR Safe

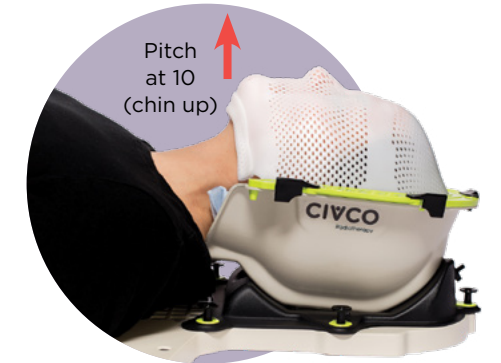

**Solstice™**  
SRS Immobilization System

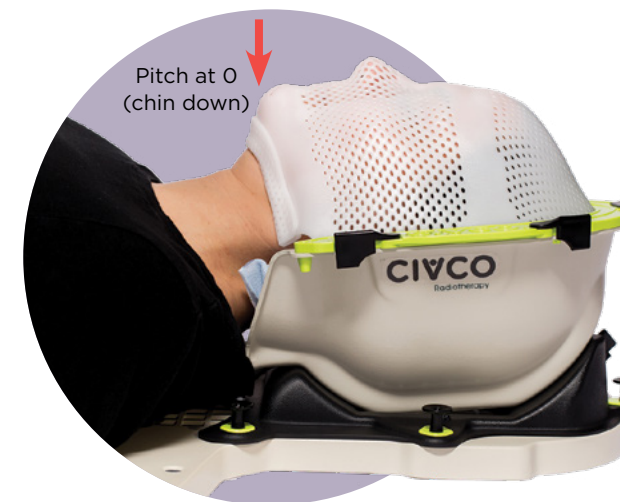

Variable pitch capability provides increased setup options in CT simulation, MR imaging (with glass fiber MR version) and corrective positioning flexibility during treatment setup.





# Solstice SRS System Customization



Carbon Fiber with ClearVision Thermoplastic and Precise Bite

visionrt COMPATIBLE



Glass Fiber with IMRT Reinforced Thermoplastic



CONTACT SALES  
FOR TRUPOINT  
ARCH™ ORDERING  
INFORMATION

## SGRT Starter Kit

Kit includes: Head Support, Solstice ClearVision Open-face Thermoplastic, Standard (x10), 20 x 35 cm Chamfered AccuForm Cushion (x10), Precise Bite (x5)

CHS03SGK	Carbon Fiber, Posifix
CHS04SGK	Carbon Fiber, Type-S
CHS03MRSGK	Glass Fiber MR, Posifix
CHS04MRSGK	Glass Fiber MR, Type-S

## Standard Starter Kit

Kit includes: Head Support, Solstice IMRT Reinforced Thermoplastic Style 18, Standard (x10), 20 x 35 cm Chamfered AccuForm Cushion (x10), Precise Bite (x5)

CHS03K	Carbon Fiber, Posifix
CHS04K	Carbon Fiber, Type-S
CHS03MRK	Glass Fiber MR, Posifix
CHS04MRK	Glass Fiber MR, Type-S



**Universal Couxtop**  
Type-S and Posifix Long Extensions allow for direct attachment of Solstice.  
See page 12.



**Alta and TotalRT All in One Solutions**  
Allow for direct attachment of Solstice.  
See pages 38-40.

# Individual Order Items



visionrt COMPATIBLE



## Head Support

CHS03	Carbon Fiber, Posifix (left photo) Qty 1
CHS04	Carbon Fiber, Type-S, Qty 1
CHS03MR	Glass Fiber, MR, Posifix (right photo), Qty 1
CHS04MR	Glass Fiber, MR, Type-S, Qty 1

## ClearVision Thermoplastic

MTAPCID1832SG	Standard (left photo), Qty 5
MTAPCIN1832SG	Narrow (right photo), Qty 5

## IMRT Reinforced Thermoplastic Style 18

MTAPCID1832	Standard (left photo), Qty 5
MTAPCIN1832	Narrow (right photo), Qty 5

## Shoulder Thermoplastic

MTAPSSTS	Type-S, Aquaplast RT, Solid (left photo), Qty 5
MTAPSSPF	Posifix, Aquaplast RT, Solid (right photo), Qty 5

## AccuForm Cushions

MTACL2035	20 x 35 cm Chamfered, Qty 1
MTACL2035HF	20 x 35 cm Chamfered, Half Fill, Qty 1

## Precise Bite

See page 105 for additional Precise Bite options.

MTCBPBITE	Standard, Qty 5
MTCBPBITES	Small, Qty 5

See Vision RT's compatibility statement on back cover.



# SRS Adapter for Portrait & Type-S Devices

## FLEXIBILITY TO PERFORM SRS TREATMENTS WITH PORTRAIT & TYPE-S DEVICES

Non-invasive solution that enables submillimetric positioning for stereotactic radiosurgery treatments on the Portrait Intracranial Head & Neck Devices and other Type-S devices. The system reduces motion, allowing for maximum dose to the tumor while minimizing radiation delivered to the surrounding healthy tissue.

- Enables single isocenter SRS treatment for multiple lesions when used in conjunction with Encompass SRS Fibreplast Masks
- Accommodates a variety of SRS headrests and cushion supports for a fully customizable setup
- Easy to set up and can help to minimize procedure time and cost

<b>*RT-4600-03</b>	SRS Adapter (includes headrests)
<b>*RT-4600-03-MRI</b>	MR SRS Adapter (includes headrests)

\*Not validated for HyperArc



SRS Adapter shown on Portrait with SRS Cushion Support and AccuForm

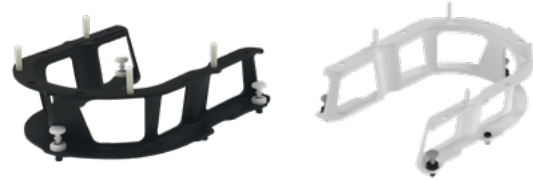

SRS Adapter

MR SRS Adapter

# Encompass SRS Adapter Thermoplastic Options

## SRS Headrests

Available in different heights for positioning patients in a comfortable, neutral head and neck position. They support the patient's head while forming the Encompass SRS Fibreplast Mask for simulation.

<b>RT-4600-10</b>	E0 SRS Headrest (included with SRS Adapter)
<b>RT-4600-12</b>	E2 SRS Headrest (included with SRS Adapter)
<b>RT-4600-14</b>	E4 SRS Headrest (included with SRS Adapter)
<b>RT-B889KYCF2</b>	Encompass SRS Fibreplast System with Optional IntegraBite See page 60 for more information

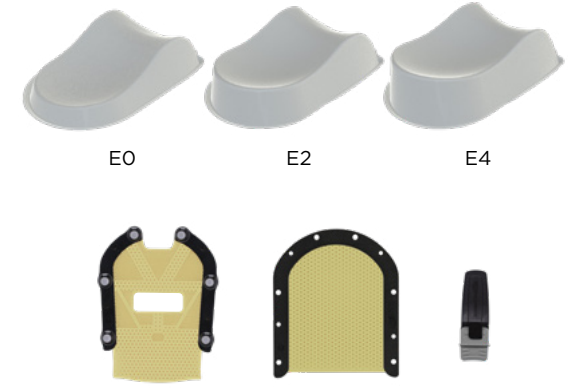

## SRS Cushion Support

Compatible with AccuForm and an anterior Encompass SRS Fibreplast Mask.

<b>RT-4600-20</b>	SRS Cushion Support (not included with Encompass or SRS Adapter)
<b>RT-B889KYCF2A</b>	Encompass SRS Anterior Only Fibreplast Mask to be used with SRS Cushion Support (includes AccuForm U Head Cushion, 200 mm x 350 mm)





# AN OPEN LETTER TO FEAR

Dear Fear,

There is no place for you here.  
No reason for being.  
We know the anxiety you bring.  
And we loathe it.  
So, we took you on.  
Designing rigid radiation immobilization masks  
that allow a patient to see and breathe and feel as  
physically and mentally comfortable as possible.  
Because when patients are put more at ease,  
they're in a better position for better outcomes.  
You can't outrun us.  
We see you.  
Take that, fear.

 **CQ MEDICAL**<sup>™</sup>  
Care Smarter  
Formerly CIVCO RT<sup>™</sup> and Qfix<sup>®</sup>



# Head & Neck and Thermoplastics



77-88

TYPE-S DEVICES & THERMOPLASTICS

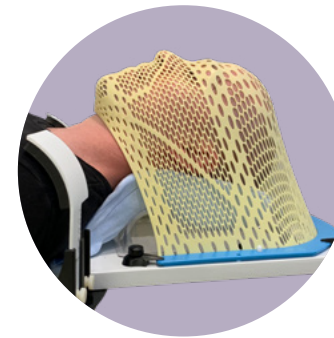

89-93

UNI-FRAME DEVICES & THERMOPLASTICS



94-98

POSIFIX DEVICES & THERMOPLASTICS



100-101

PEDIATRIC PROFORM DEVICES & THERMOPLASTICS



102

SOLSTAT IMMOBILIZATION SYSTEM

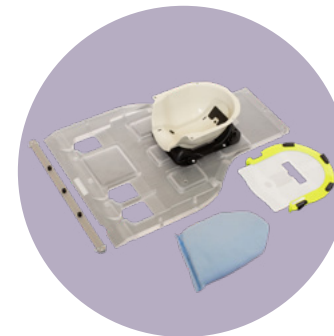

103

M.C. INSPIRE BASEPLATE



104

CUSTOMIZABLE HEAD SUPPORT

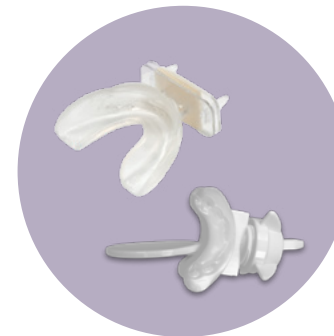

105-106

BITE POSITIONERS & GRAYDUCK DART ORAL POSITIONING STENT



107

ACCUFORM CUSHIONS



109-112

HEADRESTS, SPACERS & WEDGES



113-114

ADAPTERS



114-115

RAPIDHEAT OVEN & WATER BATH



# CHOOSING A HEAD & NECK POSITIONING SYSTEM

## Type-S™



The Type-S system was designed for IMRT and conformal treatments and is intended to provide minimal attenuation throughout 360° of treatment angles. Type-S thermoplastic masks offer the greatest variety of reinforced patterns, materials and frame type.

Pages 77-88

## Uni-frame®

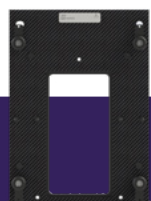

The Uni-frame system has become an industry standard solution for Head Only thermoplastic masks. They are available in a variety of standard and reinforced patterns, including Tranquility Series masks and the highly conformal ZENTEC material.

Pages 89-93

<b>COMPATIBILITY</b>	CT, MR, Photon	CT, MR, Photon
<b>THERMOPLASTIC MATERIAL</b>	Fibreplast, Aquaplast RT, ZENTEC	Fibreplast, Aquaplast RT, ZENTEC
<b>SPECIAL FEATURES</b>	<ul style="list-style-type: none"> <li>• Integrated Shim</li> <li>• Pre-cut eye and mouth</li> <li>• Open-face, surface tracking</li> <li>• Variable Perf and reinforced patterns</li> <li>• Larynx extension</li> <li>• Neck relief</li> <li>• Pediatric option</li> </ul>	<ul style="list-style-type: none"> <li>• Pre-cut eye and mouth</li> <li>• Open-face, surface tracking</li> <li>• Variable Perf and reinforced patterns</li> </ul>
<b>FRAME</b>	<ul style="list-style-type: none"> <li>• Continuous</li> <li>• Split</li> </ul>	<ul style="list-style-type: none"> <li>• Continuous</li> <li>• Split</li> </ul>



## Posifix®



Posicast® thermoplastic masks were specifically formulated for use with the Posifix Patient Positioning System. They are drape-style which requires less stretching, therefore, resulting in less shrinkage. Drape-style masks allow for closer attachment of the mask to the patient.

Pages 94-98

## Pediatric ProForm™



The ProForm Head & Neck system was developed for proton therapy, but offers additional use to treat pediatric patients undergoing conventional photon radiotherapy. ProForm accepts a dedicated thermoplastic mask, available in many reinforced patterns and design styles. Masks are sold in boxes of five and are disposable.

Pages 100-101

<b>COMPATIBILITY</b>	CT, MR, Photon	CT, MR, Photon, Proton
<b>THERMOPLASTIC MATERIAL</b>	Posicast, Fibreplast, Aquaplast RT	Aquaplast RT
<b>SPECIAL FEATURES</b>	<ul style="list-style-type: none"> <li>• Open-face</li> <li>• Larynx extension</li> <li>• Smooth coating</li> <li>• Pediatric option</li> </ul>	<ul style="list-style-type: none"> <li>• Pre-cut eye and mouth</li> <li>• Open-face, surface tracking</li> <li>• Reinforced patterns</li> <li>• Pediatric option</li> </ul>
<b>FRAME</b>	<ul style="list-style-type: none"> <li>• Drape</li> </ul>	<ul style="list-style-type: none"> <li>• Continuous (Head Only)</li> <li>• Continuous to Drape (Head, Neck &amp; Shoulders)</li> </ul>



## THERMOPLASTIC MATERIALS

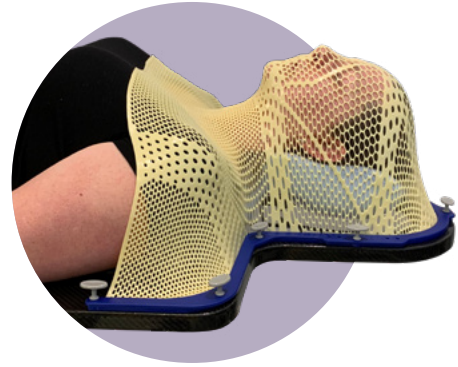

### FIBREPLAST®

Fibreplast, our premium propriety thermoplastic, is more rigid than standard thermoplastics and shrinks less. Fibreplast is available in Micro Perforation (2.4 and 3.2 mm thickness), Standard Perforation (2.4 and 3.2 mm thickness), and Variable Perforation (2.4 and 3.2 mm thickness), which maximizes rigidity while minimizing the bolus effect.

- Water Bath and Dry Heat Oven compatible

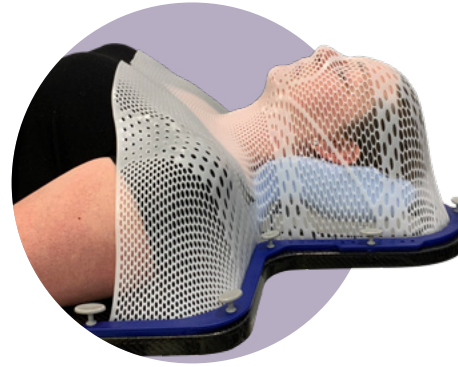

### AQUAPLAST RT™

We are the inventors of Aquaplast RT. Its rigidity, resistance to shrinkage, and easy molding qualities are unparalleled in the industry. Aquaplast RT is available in Micro Perforation (2.4 and 3.2 mm thickness), Standard Perforation (2.4, 3.2 and 4.8 mm thickness), and Variable Perforation (2.4 and 3.2 mm thickness), which maximizes rigidity while minimizing the bolus effect.

- Water Bath and Dry Heat Oven compatible



### ZENTEC™

ZENTEC requires less heating time than Aquaplast RT thermoplastics and has an established reputation of being highly conforming masks. The 2.4 mm thickness masks provide a lighter feeling, which offers a more pleasant experience for anxious patients. The 3.2 mm thickness offers a similarly conforming mask.

- Water Bath compatible



### POSICAST®-LITE & POSICAST-PLUS

Posicast-Lite feels like a traditional thermoplastic with a smooth spray coating on both sides of the mask. They have a drape-style design that requires less stretching which results in minimal shrinkage during cooling.

Posicast-Plus has a soft polyurethane coating on the patient-contacting side for comfort, while the other side features a smooth spray coating to facilitate marking treatment fields on the mask. It is a drape-style design that requires less stretching which results in minimal shrinkage during cooling.

- Water Bath and Dry Heat Oven compatible

## THERMOPLASTIC SPECIAL FEATURES



### FREEDOMVIEW™ & OPEN EYE OPEN MOUTH

Eye openings help reduce anxiety while capturing bridge of nose. Mouth opening allows for tongue displacement and free breathing.

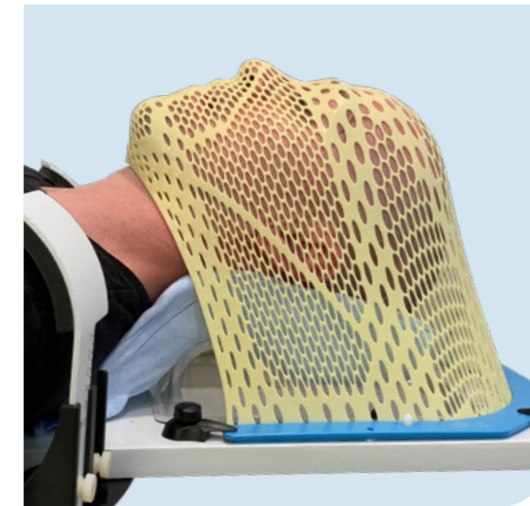
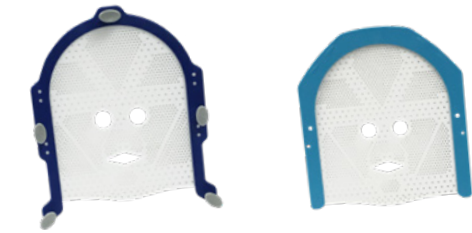

### IMRT REINFORCED™ & VARIABLE PERF™ PATTERNS

Features a combination of standard perforated and solid/micro perforation thermoplastic in the mask design to provide rigidity and secure immobilization for treatment. By providing solid/micro perforated bands in areas where a secure hold is essential while maintaining standard perforation elsewhere, these masks provide a balance of immobilization and comfort.

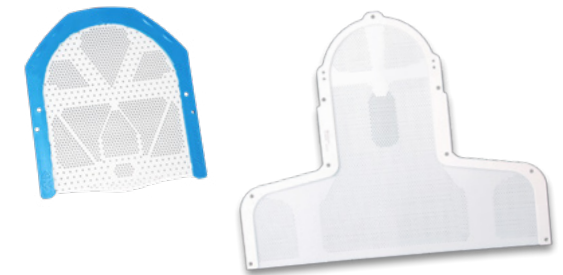

### CLEARVISION™ 2 & ASSURE OPEN VIEW

Reduces patient anxiety while allowing real time patient monitoring using optical tracking systems.

visionrt | COMPATIBLE

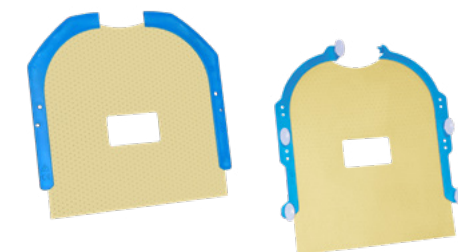



# THERMOPLASTIC FRAME STYLES



## INTEGRATED SHIM

The innovative Integrated Shim allows independent height adjustment at each pin, providing completely customizable immobilization. Each Integrated Shim can be adjusted in discrete 0.5 mm increments, with a total range of 4 mm.

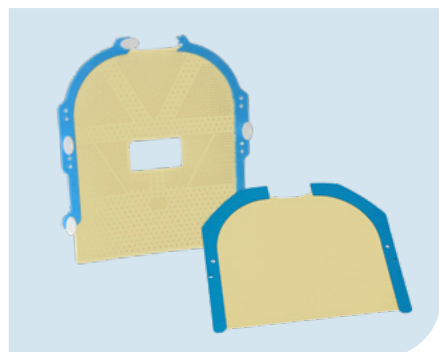

## SPLIT-FRAMES

Split-frames reduce the stretching required of the thermoplastic, thus forming a more rigid mask. These masks also accommodate patients with long hair.



## HEAD ONLY

Head Only masks are perfect for everything from whole brain to complex IMRT treatments.

The Uni-frame traditional frames are especially useful for patients with smaller heads. The Uni-frame Slimline frames are useful for patients with larger heads.

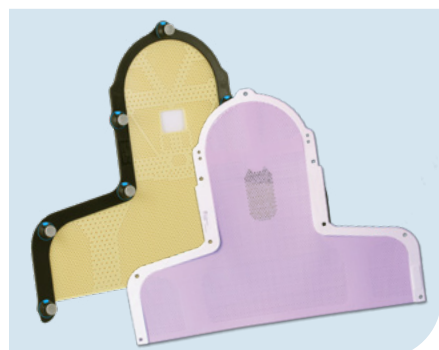

## HEAD, NECK & SHOULDERS

Head, Neck & Shoulders masks extend below the patient's shoulders, providing additional immobilization.

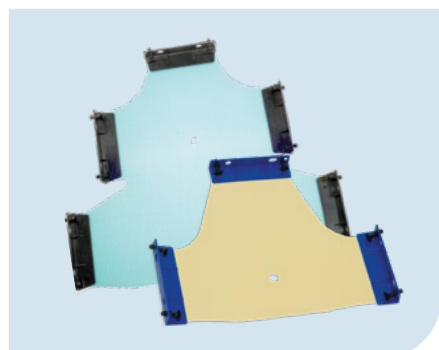

## DRAPE STYLE

Posifix 3-point (head and neck) and 5-point (head & shoulders) disposable, drape-style requires less stretching, therefore, resulting in less shrinkage. Drape-style masks allow for closer attachment of the mask to the patient.

# Type-S Extensions

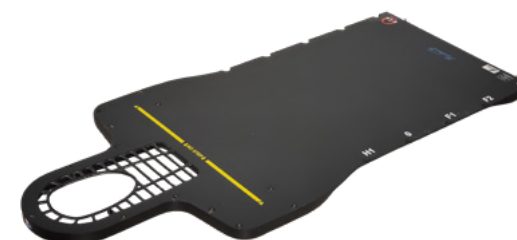
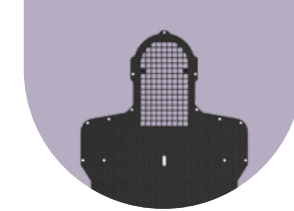

## Portrait Intracranial, Head & Neck Insert

Portrait devices and masks provide a high level of stability by limiting patient motion and reducing the probability of positioning errors.

The Portrait Insert can be extended beyond the end of the couchtop making it ideal for full 360° treatments.

Portrait accommodates supine and prone setups for patient specific treatments. Portrait is rigid while providing minimal attenuation.

RT-4552KV kVue Portrait Insert



## Universal Couchtop Long Extension

The Universal Couchtop Long Extension self-locks onto the Universal Couchtop, allowing the thermoplastic to connect to the couchtop.

See pages 10-25 for more details.

MTIL6665 Length: 39.1" (99.3 cm)

MTIL6670 Length: 49.1" (124.7 cm)

MTIL6664 Length: 53.1" (134.9 cm)

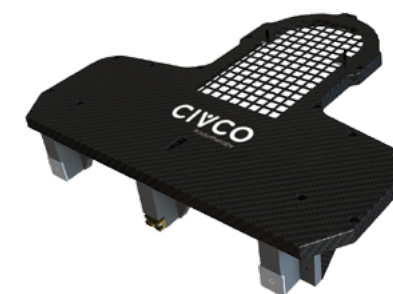

## Varian Style Extension

The Varian Style Extension hooks easily on the superior end of a Varian style endplate. An optional reloadable head, neck & shoulder frame for Type-S thermoplastics is available.

MTCFHNV



## Type-S Platforms

### Alta Multipurpose Device

Alta can extend beyond the couchtop to provide improved access to the head and neck region. The Alta Multipurpose Device is compatible with Type-S thermoplastic masks, which can be directly attached to the device. A Silverman Adapter Plate enables the use of Silverman headrests to support the cervical spine during simulation and treatment. This setup provides high-precision positioning and reproducibility for head and neck applications.

See pages 36–37 for more details.

### TotalRT All in One Platform

The TotalRT All in One Platform is designed to quickly adapt many positioning and immobilization solutions to your clinical setup and treatment needs, including head and neck.

See pages 39–40 for more details.

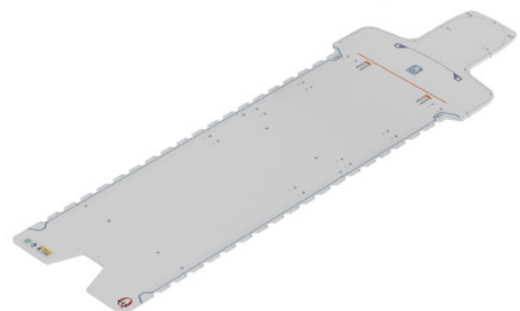

## Type-S Baseplates



Variable Axis Baseplate with Prone Face Cushion (sold separately)



Patient Setup with Variable Axis Baseplate and Prone Face Cushion



Variable Axis Baseplate with optional Adapter and Prone Headrest

### Variable Axis Baseplate

The Variable Axis Baseplate integrates with any Type-S extension or overlay to provide a tilting movement with patient fixation in either prone or supine positions. The unique variable axis design allows for natural head and neck movement and features a rotating knob to lock the baseplate into an angle position from 0°–30° in supine position and 12.5°–32.5° in prone position. The baseplate accommodates Type-S head only thermoplastics and accepts the Prone Face Cushion or the Posifix Prone Headrest via an adapter and shim.

See pages 109–111 for supine headrest options.

See page 93 for TiltPro Tilting Base.

MTCFHNAB01	Variable Axis Baseplate
MTPFC02	Prone Face Cushion
301025BLK	Posifix Prone Headrest
301035	MR Posi-S Adapter (see page 114)
MTSHIMT	Timo Shim (must be used with 301035)

## Type-S Overlays



### Portrait Intracranial, Head & Neck Device

The Portrait device offers superior immobilization for brain and head & neck radiotherapy. It is easy to use and lightweight for daily reproducibility.

- Indexes to the couchtop with either a two-pin Locating Bar or a Direct Indexing Adapter
- Utilizes Type-S thermoplastics for high stability and reduced positioning errors
- Can extend beyond couchtop for 360° treatments
- Suitable for both supine and prone setups, providing minimal attenuation while remaining rigid

RT-4552	Portrait Intracranial, Head & Neck Device
RT-4552MRI	Portrait MR Intracranial, Head & Neck Device compatible with bridges

# Type-S Overlays

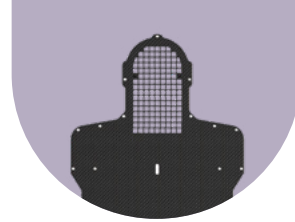

## iBEAM® Overlay Adapter

Created for the Medical Intelligence iBEAM and iBEAM EVO couchtops. The overlay is cantilevered, providing minimal attenuation in the area of treatment.

108073

## Overlay Board

Extends off the end of the treatment couch. An optional reloadable head, neck and shoulders frame for Type-S thermoplastics is available.



20CFHNSUB7	Overlay (no Vac-Lok indexing hole for larger unobstructed treatment region)
20CFHNSUB2	Overlay (with Vac-Lok indexing hole)
20CFHNSUB1P	ABS Reloadable Type-S Frame Only

## MRI Type-S Overlay

Made of fiberglass with a foam core for use in MR environments. The MRI Overlay is lightweight and three-pin indexable.



MTMRHNTYPES	(left photo)
MTMRHNPN	Narrow (right photo)

## Fixator™ Shoulder Supression System

The Fixator Shoulder Supression System is designed to enhance the benefits of the Type-S system. The Fixator extends off the couchtop and includes adjustable padded positioners to gently cup the patient's shoulders, capturing and positioning them out of the treatment field. Indexed nomenclature allows for easily recorded shoulder repositioning. Type-S Head Only IMRT Reinforced Thermoplastic masks are recommended for use with this system.



MTCFHN006	Fixator with Shoulder Cups (x2)
MTCFHN006SUB6	Shoulder Cup, Qty 1

# Portrait™ with Integrated Shim™

**Fix** A Qfix Innovation

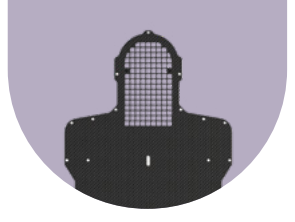

The innovative Integrated Shim allows independent height adjustment at each pin, providing completely customizable immobilization. Each Integrated Shim can be adjusted in discrete 0.5 mm increments, with a total range of 4 mm.

- Independent shimming at each pin point
- No need to remove mask to tighten or loosen
- Increased workflow efficiencies
- Increased patient comfort
- Better workflow and instant setup feedback

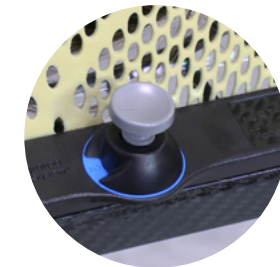

*Portrait*™ Integrated Shim™ System

### TO ADJUST SHIM HEIGHT

- Pull up to unlock
- Rotate to the desired height adjustment
- Depress to lock

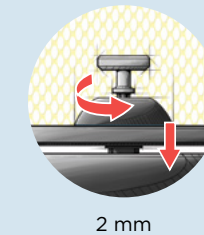

2 mm

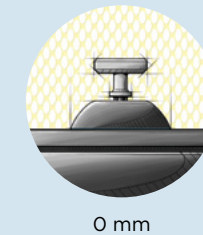

0 mm

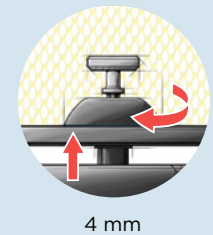

4 mm

See Fibreplast & Aquaplast RT with Integrated Shim Thermoplastic on Page 82

# Type-S Thermoplastics

Masks on this page are disposable and sold in Qty 1. Must purchase in multiples of 5.

## Fibreplast & Aquaplast RT with Integrated Shim

### VARIABLE PERF

RT-A889KYSD	Fibreplast, Head Only, 3.2 mm
RT-A892KYSD	Fibreplast, Head & Shoulder, 3.2 mm
RT-A892YSD	Aquaplast RT, Head & Shoulder, 3.2 mm

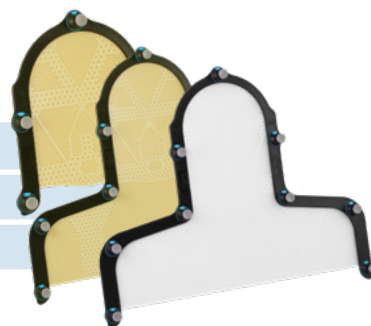

### STANDARD PERF

RT-A782KSD	Fibreplast, Head & Shoulder, 2.4 mm
------------	-------------------------------------



### ASSURE OPEN VIEW, MICRO PERF

RT-A876KSDGLF	Fibreplast, Head Only, Split frame, 3.2 mm
---------------	--



visiφnrt | COMPATIBLE

### ASSURE OPEN VIEW, VARIABLE PERF

RT-A892KYSDF	Fibreplast, Head & Shoulder, 3.2 mm
--------------	-------------------------------------



visiφnrt | COMPATIBLE



Fibreplast Variable Perf



Assure Open View with Variable Perf

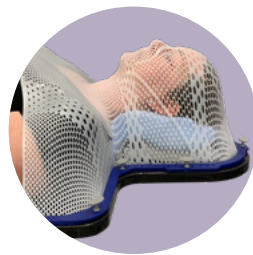

Aquaplast RT Variable Perf

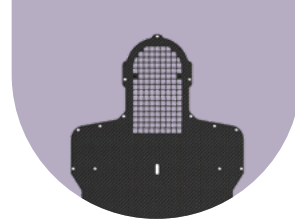

# Type-S Thermoplastics

Masks on this page are disposable and sold in Qty 1. Must purchase in multiples of 10.

## Fibreplast & Aquaplast RT Head Only

### VARIABLE PERF

RT-1889KYSD	Fibreplast, 3.2 mm
RT-1889YSD	Aquaplast RT, 3.2 mm
RT-1889YSDR	Aquaplast RT, Open Eye & Mouth, 3.2 mm



### STANDARD PERF

RT-1779KSD	Fibreplast, 2.4 mm
RT-1889KSD	Fibreplast, 3.2 mm
RT-1779SD	Aquaplast RT, 2.4 mm
RT-1889SD	Aquaplast RT, 3.2 mm

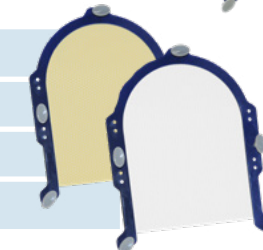

### STANDARD PERF, LONG

RT-1889KSDL	Fibreplast, 3.2 mm
RT-1779SDL	Aquaplast RT, 2.4 mm
RT-1889SDL	Aquaplast RT, 3.2 mm

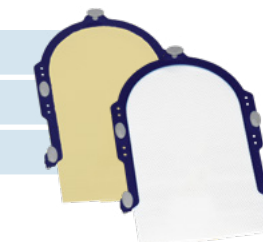

## Fibreplast & Aquaplast RT Split-frames

### VARIABLE PERF

RT-1776KYSDGXF	Fibreplast, Head Only, Extended, Assure Open View, 2.4 mm
RT-1876KYSDGLF	Fibreplast, Head Only, Long, Assure Open View, 3.2 mm



visiφnrt | COMPATIBLE

### MICRO PERF

RT-1776KSDGXF	Fibreplast, Head Only, Extended, Assure Open View, 2.4 mm
RT-1876KSDGLF	Fibreplast, Head Only, Long, Assure Open View, 3.2 mm



visiφnrt | COMPATIBLE

### STANDARD PERF

RT-1889KSD-S3	Fibreplast, Head Only, 3.2 mm
RT-1889SD-S3	Aquaplast RT, Head Only, 3.2 mm

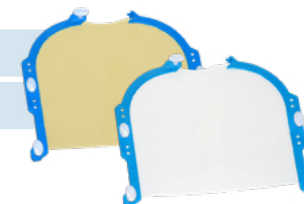

See Vision RT's compatibility statement on back cover.

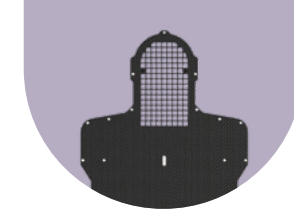



# Type-S Thermoplastics

Masks on this page are disposable and sold in Qty 1. Must purchase in multiples of 10.

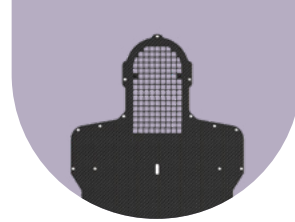

## Fibreplast & Aquaplast RT, Head, Neck & Shoulders

### VARIABLE PERF

RT-1782KYSDF	Fibreplast, Assure Open View, 2.4 mm
RT-1892KYSDF	Fibreplast, Assure Open View, 3.2 mm
RT-1892KYS	Fibreplast, 3.2 mm
RT-1892YSD	Aquaplast RT, 3.2 mm
RT-1892YSDR	Aquaplast RT, Open Eye & Mouth, 3.2 mm

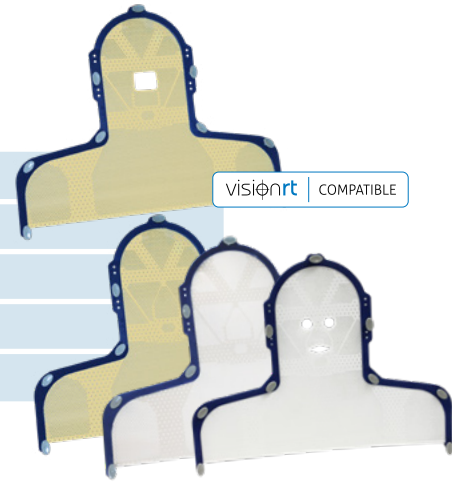

### MICRO PERF, ASSURE OPEN VIEW

RT-1778KSDF	Fibreplast, 2.4 mm
RT-1878KSDF	Fibreplast, 3.2 mm

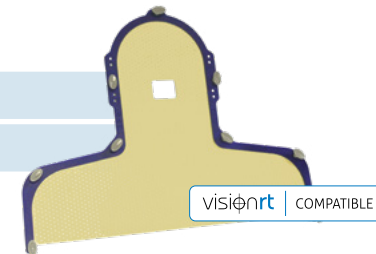

### STANDARD PERF

RT-1782KSD	Fibreplast, 2.4 mm
RT-1892KSD	Fibreplast, 3.2 mm
RT-1782SD	Aquaplast RT, 2.4 mm
RT-1892SD	Aquaplast RT, 3.2 mm

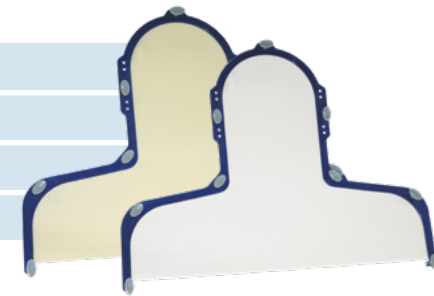

# Type-S Thermoplastics

Masks on this page are disposable and sold in Qty 5.

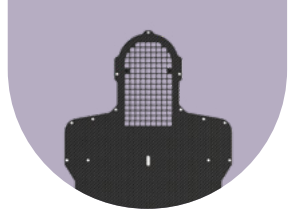

## Aquaplast RT, FreedomView

MTAPUID1832CL	Head Only, IMRT Reinforced Style 18, 3.2 mm
MTAPUID1832CLRD	Head Only, IMRT Reinforced Style 18, Radius 13", 3.2 mm
MTAPSID27NR32CL	Head, Neck & Shoulders w/ Neck Relief, IMRT Reinforced Style 27, 3.2 mm

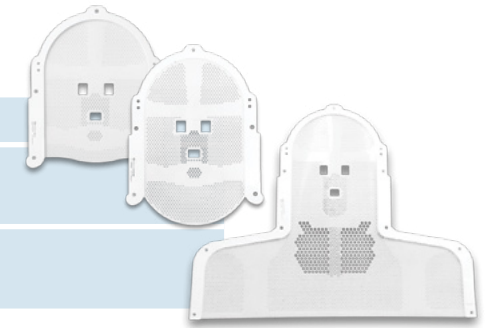

## Aquaplast RT, Shoulder Thermoplastic

MTAPSSTS	Solid, 3.2 mm
----------	---------------



## Aquaplast RT, ClearVision 2

MTAPUID1832SG	Head Only, 3.2 mm
MTAPSID2732SG	Head, Neck & Shoulders, 3.2 mm

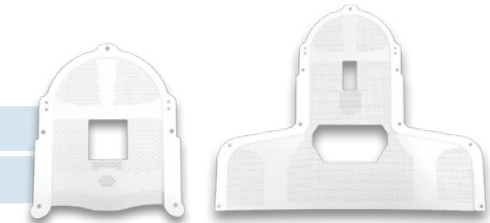

## Aquaplast RT, ClearVision

MTVRT20	Head Only, 3.2 mm
---------	-------------------

See Vision RT's compatibility statement on back cover.



FreedomView Head Only



FreedomView Head, Neck & Shoulders



Shoulder Thermoplastic



ClearVision 2 Head, Neck & Shoulders

# Type-S Thermoplastics

Masks on this page are disposable and sold in Qty 5.

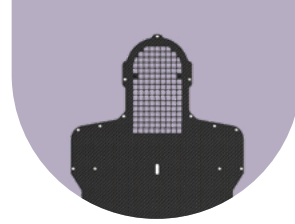

## ZENTEC, IMRT Reinforced

MTAPUID1824VT	Head Only, Style 18, 2.4 mm
MTAPUID1832VT	Head Only, Style 18, 3.2 mm
MTAPSID2724VT	Head, Neck & Shoulders, Style 27, 2.4 mm
MTAPSID2732VT	Head, Neck & Shoulders, Style 27, 3.2 mm

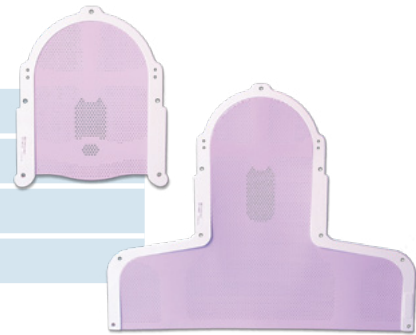

For added customizable hold, see page 88 for Reinforcement Thermoplastic Strips.

## Aquaplast RT, IMRT Reinforced

MTAPUID1824	Head Only, Style 18, 2.4 mm
MTAPUID1832	Head Only, Style 18, 3.2 mm
MTAPUID181332RD	Head Only with 13" Radius Bottom, Style 18, 3.2 mm
MTAPSID2724	Head, Neck & Shoulders, 2.4 mm
MTAPSID2732	Head, Neck & Shoulders, 3.2 mm
MTAPSID27NR24	Head, Neck & Shoulders with Neck Relief, Style 27, 2.4 mm
MTAPSID27NR32	Head, Neck & Shoulders with Neck Relief, Style 27, 3.2 mm

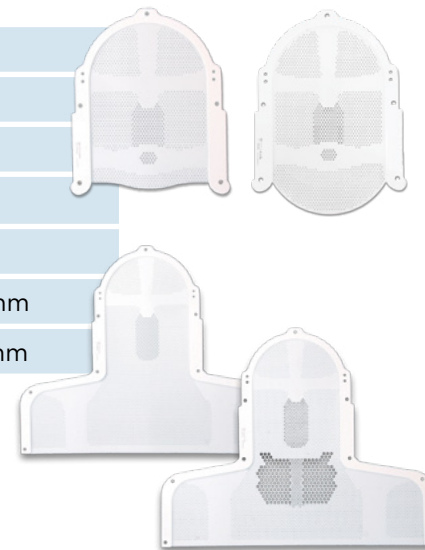

ZENTEC  
IMRT Reinforced  
Style 27



Aquaplast RT IMRT  
Reinforced Style 18



Aquaplast RT Style 18  
Radius Bottom



Aquaplast RT IMRT  
Reinforced Style 27

# Type-S Thermoplastics

Masks on this page are disposable (unless otherwise noted) and sold in Qty 5.

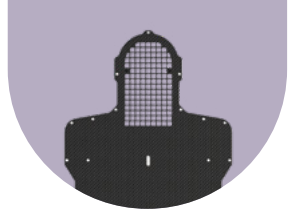

## Aquaplast RT, Standard Perforation

MTAPUD2.4	Head Only, 2.4 mm
MTAPUD	Head Only, 3.2 mm
MTAPSD2.4	Head, Neck & Shoulders, 2.4 mm
MTAPSD3.2	Head, Neck & Shoulders, 3.2 mm

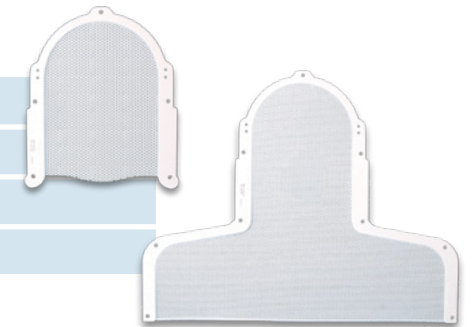

## Aquaplast RT, Pediatric Standard Perforation

MTAPSP2.4	Head, Neck & Shoulders, Reloadable, 2.4 mm
20CFHNPSUB1P	Reloadable Frame

For more pediatric options, see page 101.



Aquaplast RT  
Standard  
Perforation



# Type-S Thermoplastics

Masks on this page are disposable (unless otherwise noted) and sold in Qty 5.

## ADDITIONAL AQUAPLAST RT THERMOPLASTICS

IMRT Reinforced	2.4 mm	3.2 mm
Style 18, Head Only, 12" Extended	-	MTAPUID181232
Style 18, Head Only, 14" Extended	-	MTAPUID181432
Style 20, Head Only	MTAPUID2024	MTAPUID2032
Style 22, Head Only	-	MTAPUID2232
Style 29, Head, Neck & Shoulders	MTAPSID2924	MTAPSID2932
Style 29, Head, Neck & Shoulders with Neck Relief	MTAPSID29NR24	MTAPSID29NR32
IMRT Reinforced, Reloadable	2.4 mm	3.2 mm
Style 18, Head Only	-	MTAPUIR1832
Style 20, Head Only	-	MTAPUIR2032
Standard Perforation	2.4 mm	3.2 mm
Head Only, 12" Extended	MTAPUD1224	-
Head Only, 14" Extended	MTAPUD1424	-
Standard Perforation, Reloadable	2.4 mm	3.2 mm
Head Only	MTAPUR2.4	MTAPUR
Head Only, 12" Extended	MTAPUR122.4	-
Head, Neck & Shoulders	-	MTAPS3.2
Solid w/ Perforated Nose	2.4 mm	3.2 mm
Head Only	MTAPUD002	-
Head, Neck & Shoulders	MTAPSD001	-
Reinforcement Thermoplastic Strips	2.4 mm	3.2 mm
1.375 x 24" (3.5 x 70 cm), Qty 1	-	MTAPS18391
1.375 x 9.75" (3.5 x 25 cm), Qty 5	-	MTAPS25
1.375 x 13.75" (3.5 x 35 cm), Qty 5	-	MTAPS35

Lead times for these masks vary; contact your sales representative.

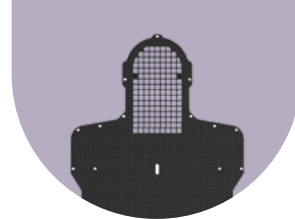

Style 18



Style 20



Style 22



Style 29



Standard Perforation

# Uni-frame Baseplates

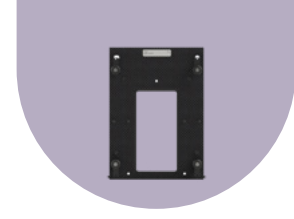

ProBoard™ Flat Carbon Fiber Headboard



Polycarbonate Headboard

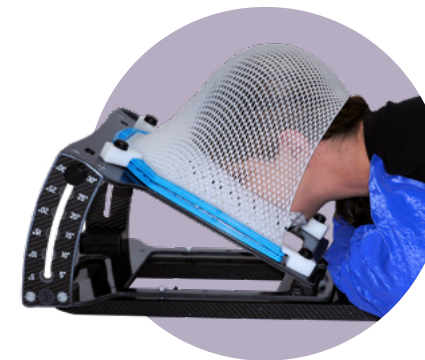

## Headboards

RT-4525TILT-A	ProBoard Flat Carbon Fiber Headboard
RT-4548	Polycarbonate Headboard
RT-4525TILT-B	Upgrade Kit - ProBoard for Tilt-Pro Tilting Base
RT-4484-16/4X6	Prone Mask Foam, Qty 8
RT-1969	Uni-frame Mask for use in prone technique*

\*Mask is disposable and sold in Qty 1. Must purchase in multiples of 4.

## Tilt-Pro™ Tilting Base

Tilt-Pro allows precise angling of the head for prone and supine treatments, avoiding critical structures. It adapts easily to most couchtops, simulator, and CT tables and is designed for one-step molding and positioning of Type-S and Uni-frame masks. Indexable channel arms adjust from 0 to 30° in 5° increments.

See page 89 for the ProBoard Flat Carbon Fiber Headboard.

### ALSO COMPATIBLE WITH TYPE-S SYSTEM

RT-4525TILT	Tilt-Pro Tilting Base with Low-Pro Swivel Locks
-------------	---

## Prone CSA Kit™

This device simplifies the molding of prone masks. The kit includes everything needed to use the Tilt-Pro Base for Prone Cranial Spinal Axis (CSA) treatment; a molding fixture (for forming the prone mask), prone mask foam (to cushion the prone mask), and Double-High Nylon Swivel Locks (for securing two masks at once).

### ALSO COMPATIBLE WITH TYPE-S SYSTEM

RT-4521CSA	Prone Cranial Spinal Axis (CSA Kit)
------------	-------------------------------------

# Uni-frame Baseplates

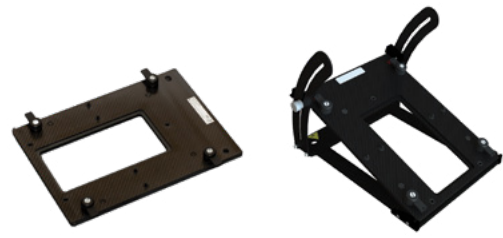

## Carbon Fiber Supine Baseplate

MT20100CF	Standard
MT20103CF	Tilting

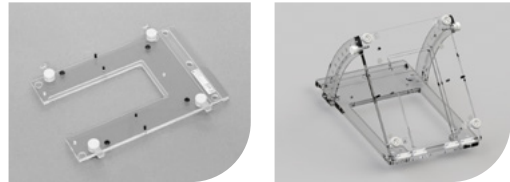

## Acrylic Supine Baseplate

MT20100	Standard
MT20108	Standard, for use with Accuray Cyberknife®
MT20104	Tilting

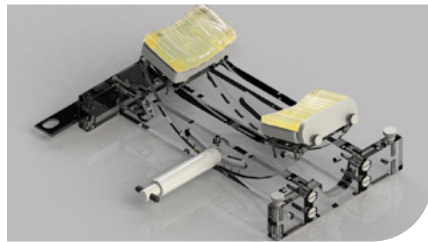

## Prone Head Holder

The Prone Head Holder provides variable head angle positioning and features gel chin and forehead pads. This accessory unit integrates with the acrylic standard supine baseplate or the carbon fiber standard supine baseplate (MT20100, MT20100CF—see above) for patient fixation with a Uni-frame thermoplastic mask.

MT202	
-------	--

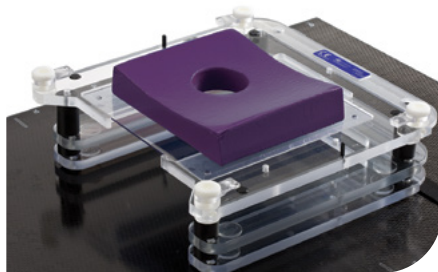

## Lateral Baseplate

The Lateral Baseplate is specially padded for comfortable, reproducible lateral head & neck positioning. It accepts a special-width reloadable frame and thermoplastics and comes with a Lateral Head Cushion.

MTLTBP	Lateral Baseplate (includes lateral head cushion & reloadable frame)
MTLTBPIAT01	Lateral Head Cushion with Indexing Plate
MTLTBP2	Reloadable Lateral Frame
MTAPUL	Perforated 3.2 mm Thermoplastic, Qty 5
MTAPUL2.4	Perforated 2.4 mm Thermoplastic, Qty 5

# Uni-frame Thermoplastics

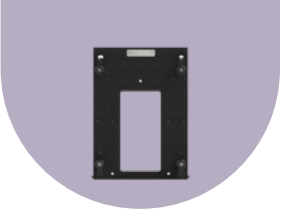

Masks on this page are disposable and sold in Qty 1. Must purchase in multiples of 5.

## Traditional Frame

STANDARD PERF	
RT-1779	Aquaplast RT, 2.4 mm
RT-1889	Aquaplast RT, 3.2 mm
STANDARD PERF, LONG	
RT-1779L	Aquaplast RT, 2.4 mm
RT-1889L	Aquaplast RT, 3.2 mm

## Slimline Frame

VARIABLE PERF	
RT-1889KYS	Fibreplast, 3.2 mm
RT-1889YS	Aquaplast RT, 3.2 mm
RT-1889YSR	Aquaplast RT, Open Eye & Mouth, 3.2 mm
STANDARD PERF	
RT-1779KS	Fibreplast, 2.4 mm
RT-1889KS	Fibreplast, 3.2 mm
RT-1779S	Aquaplast RT, 2.4 mm
RT-1889S	Aquaplast RT, 3.2 mm
RT-1989S	Aquaplast RT, 4.8 mm (must be purchased in multiples of 4)
STANDARD PERF, LONG	
RT-1779KSL	Fibreplast, 2.4 mm
RT-1889KSL	Fibreplast, 3.2 mm
RT-1779SL	Aquaplast RT, 2.4 mm
RT-1889SL	Aquaplast RT, 3.2 mm



# Uni-frame Thermoplastics

Masks on this page are disposable. Slimline Split are sold in Qty 1 and must be purchased in multiples of 5. All others are sold in Qty 5.

## Slimline, Split Frame

### VARIABLE PERF, LONG

RT-1889KYSGLF Fibreplast, Assure Open View, 3.2 mm

### STANDARD PERF

RT-1889KS-S3 Fibreplast, 3.2 mm

RT-1889S-S3 Aquaplast RT, 3.2 mm



## FreedomView, IMRT Reinforced Style 18

MTAPUI1832CL Aquaplast RT, Head Only, 3.2 mm

MTAPUIR1832CL Aquaplast RT, Head Only, Reloadable, 3.2 mm

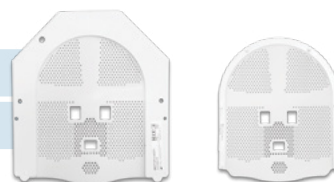

## ClearVision

MTVRTW Aquaplast RT, Head Only, Wide, 3.2 mm



For added customizable hold, see page 93 for Reinforcement Thermoplastic Strips.

## ZENTEC, IMRT Reinforced Style 18

MTAPUI1824VT Head Only, 2.4 mm

MTAPUIW1824VT Head Only, Wide, 2.4 mm

MTAPUIW1832VT Head Only, Wide, 3.2 mm



## Aquaplast RT, IMRT Reinforced Style 18

MTAPUI1824 Head Only, 2.4 mm

MTAPUI1832 Head Only, 3.2 mm

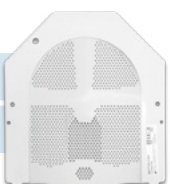

FreedomView IMRT Reinforced Style 18



ClearVision



ZENTEC IMRT Reinforced Style 18



Aquaplast RT IMRT Reinforced Style 18

# Uni-frame Thermoplastics

Masks on this page are disposable and sold in Qty 5.

## Aquaplast RT, Standard Perforation

MTAPU2.4 Head Only, 2.4 mm

MTAPU Head Only, 3.2 mm

MTAPUW2.4 Head Only, Wide, 2.4 mm

MTAPUW Head Only, Wide, 3.2 mm

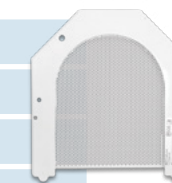

## ADDITIONAL AQUAPLAST RT THERMOPLASTICS

Standard Perforation	1.6 mm	2.4 mm	3.2 mm
1.6 mm	MTAPU1.6	-	-
12" Extended	-	MTAPU122.4	MTAPU12
12" Extended, Wide	-	MTAPUW122.4	-
14" Extended	-	MTAPU142.4	MTAPU14

Reinforcement Thermoplastic Strips	1.6 mm	2.4 mm	3.2 mm
1.375 x 24" (3.5 x 70 cm), Qty 1	-	-	MTAPS18391
1.375 x 9.75" (3.5 x 25 cm), Qty 5	-	-	MTAPS25
1.375 x 13.75" (3.5 x 35 cm), Qty 5	-	-	MTAPS35

Lead times for these masks vary; contact your sales representative. All disposable thermoplastics are MR Safe.



Standard Perforation

# Posifix Extensions



## Universal Couchtop Long Extension

The Universal Couchtop Long Extension self-locks onto the Universal Couchtop, allowing the thermoplastic to connect to the couchtop.

See pages 10–25 for more info.

<b>MTIL6666</b>	Length: 39.1" (99.3 cm)
<b>MTIL6668</b>	Length: 39.1" (99.3 cm) trUpoint ARCH SRS/SRT System compatible
<b>MTIL6672</b>	Length: 49.1" (124.7 cm)
<b>MTIL6671</b>	Length: 49.1" (124.7 cm) trUpoint ARCH SRS/SRT System compatible

## Varian Style Extension

The Varian Style Extension hooks easily on the superior end of the Varian style endplate. Like the Universal Couchtop extensions, this extension allows for 360° treatment of the head and neck with minimal attenuation.

<b>108010</b>	Varian Exact compatible
<b>108020</b>	trUpoint ARCH SRS/SRT System compatible



# Posifix Baseplates

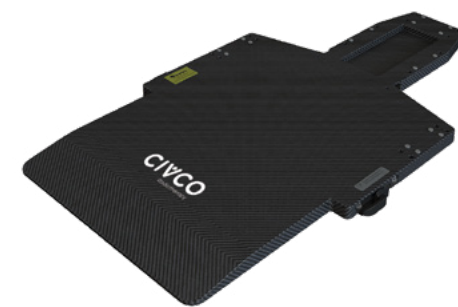

## Head, Neck & Shoulders Baseplates

Carbon fiber or Acrylic Posifix baseplates for head only and head, neck and shoulder fixation.

<b>102021</b>	Posifix-2 Baseplate, Carbon Fiber
<b>101019</b>	Posifix-1 Baseplate, Acrylic, trUpoint ARCH SRS/SRT System compatible
<b>013159</b>	Two-Pin Baseplate Storage, compatible with two-pin Posifix and Posirest baseplates and most other two-pin ready baseplates

## Head Only Baseplates

Carbon fiber or Acrylic Posifix baseplates for head only fixation.

<b>104021</b>	Posifix-4 Baseplate, Carbon Fiber
<b>105021</b>	Posifix-5 Baseplate, Acrylic

## Posifix Variable Axis Baseplate

The Variable Axis Baseplate integrates with any Posifix extension, overlay or baseplate to provide a tilting movement with patient fixation in either prone or supine positions. The unique variable axis design allows for natural head and neck movement and features a rotating knob to lock the baseplate into an angle position from 0°–30° in supine position and 12.5°–32.5° in prone position. The baseplate accommodates Posifix head only thermoplastics and accepts all supine and prone Posifix headrests (sold separately).

See pages 109–111 for headrest options.

<b>107065</b>	Posifix Variable Axis Baseplate, Carbon Fiber
---------------	---

## iBEAM® Overlay Adapter

Created for the Medical Intelligence iBEAM and iBEAM EVO couchtops. The overlay is cantilevered, providing minimal attenuation in the area of treatment.

<b>108072</b>	trUpoint ARCH SRS/SRT System compatible
---------------	---



# Posifix Thermoplastics

Masks on this page are disposable and sold in Qty 1. Must purchase in multiples of 10.

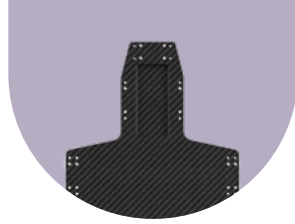

## Fibreplast & Aquaplast RT, Head Only (3-Point)

RT-1778KPR3DF	Fibreplast, Micro Perf, Assure Open View, 2.4 mm
RT-1782KPR3D	Fibreplast, Standard Perf, 2.4 mm
RT-1778KPR3D	Fibreplast, Micro Perf, 2.4 mm
RT-1782PR3D	Aquaplast RT, Standard Perf, 2.4 mm
RT-1778PR3D	Aquaplast RT, Micro Perf, 2.4 mm

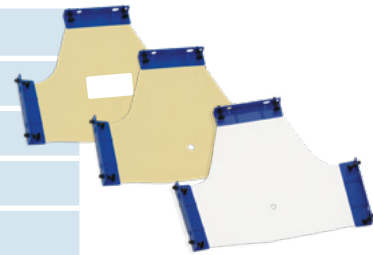

## Fibreplast & Aquaplast RT, Head, Neck & Shoulders (5-Point)

RT-1778KPR5DF	Fibreplast, Micro Perf, Assure Open View, 2.4 mm
RT-1782KPR5D	Fibreplast, Standard Perf, 2.4 mm
RT-1778KPR5D	Fibreplast, Micro Perf, 2.4 mm
RT-1782PR5D	Aquaplast RT, Standard Perf, 2.4 mm
RT-1778PR5D	Aquaplast RT, Micro Perf, 2.4 mm

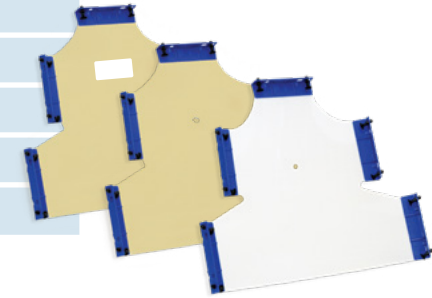

## 3-Point, 4-Point & 5-Point Reloadable Masks

RT-1782PR3	Aquaplast RT 3-Point Mask, Standard Perf, 2.4 mm
RT-1778PR3	Aquaplast RT 3-Point Mask, Micro Perf, 2.4 mm
RT-1782PR4	Aquaplast RT 4-Point Mask, Standard Perf, 2.4 mm
RT-1782PR5	Aquaplast RT 5-Point Mask, Standard Perf, 2.4 mm
RT-1778PR5	Aquaplast RT 5-Point Mask, Micro Perf, 2.4 mm

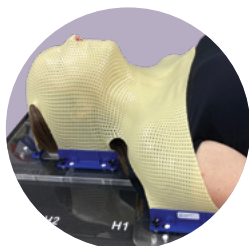
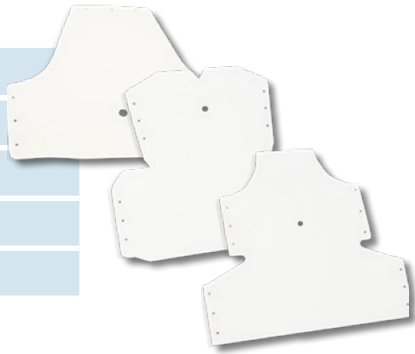

Head, Neck & Shoulders

# Posifix Thermoplastics

Masks on this page are disposable and sold in Qty 10.

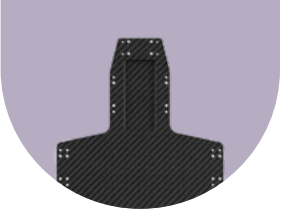

## Posicast, Head Only

772030	Posicast-Lite, 2.3 mm
930030	Posicast-Plus, 2.3 mm
772044	Posicast-Lite with Larynx Extension, 2.3 mm
930044	Posicast-Plus with Larynx Extension, 2.3 mm



## Posicast, Head Only, Open-face

970031	Posicast-Lite, trUpoint ARCH SRS/SRT System compatible, 2.3 mm
--------	---



## Posicast, Head, Neck & Shoulders

772145	Posicast-Lite, 2.3 mm
930145	Posicast-Plus, 2.3 mm

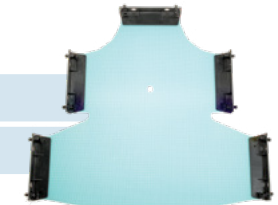

## Posicast, Pediatric

930033	Posicast-Plus, Head Only, 2.3 mm
930055	Posicast-Plus, Head, Neck & Shoulders, 2.3 mm

For more pediatric options, see page 101.

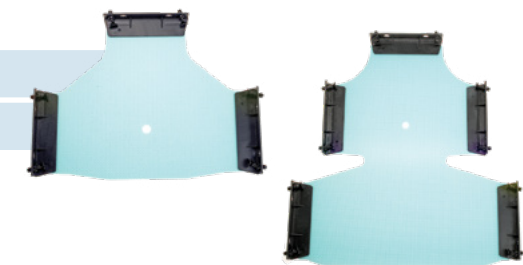

Head Only



Head Only with Larynx Extension



Head Only with Open-face



Head, Neck & Shoulders

# Posifix Thermoplastics



## Chin Strap Thermoplastic

772021 Posicast, Qty 10



## Shoulder Thermoplastic

MTAPSSPF Aquaplast RT, Solid, Qty 5



## Posicast Microperfo Plate

924392 Micro perforation, fuzzy coating on one side. 43 x 92 cm, 2.3 mm thick, Qty 10.



Chin Strap Thermoplastic



Shoulder Thermoplastic

# L-Profile Thermoplastic Masks

Masks on this page are disposable and sold in Qty 1. Must purchase in multiples of 10.

These masks allow for 3-point and 5-point immobilization utilizing a L-Profile design which locks into the device via the L design. They are available in Aquaplast RT and Fibreplast material in 2.4 mm and 3.2 mm thicknesses.

## Head-Only (3-Point)

- RT-1778KFORF3 Fibreplast, Micro Perf, Assure Open View, 2.4 mm
- RT-1876KFORF3 Fibreplast, Micro Perf, Assure Open View, 3.2 mm
- RT-1889KYFORF3 Fibreplast, Variable Perf, Assure Open View, 3.2 mm
- RT-1782ORF3 Aquaplast RT, Standard Perf, 2.4 mm
- RT-1778ORF3 Aquaplast RT, Micro Perf, 2.4 mm
- RT-1882ORF3 Aquaplast RT, Standard Perf, 3.2 mm



## Head, Neck & Shoulders (4-Point)

- RT-1782ORF4 Aquaplast RT, Standard Perf, 2.4 mm
- RT-1778ORF4 Aquaplast RT, Micro Perf, 2.4 mm



## Head, Neck & Shoulders (5-Point)

- RT-1782KORF5 Fibreplast, Standard Perf, 2.4 mm
- RT-1778KORF5 Fibreplast, Micro Perf, 2.4 mm
- RT-1778KFORF5 Fibreplast, Micro Perf, Assure Open View, 2.4 mm
- RT-1876KFORF5 Fibreplast, Micro Perf, Assure Open View, 3.2 mm
- RT-1889KYFORF5 Fibreplast, Variable Perf, Assure Open View, 3.2 mm
- RT-1782ORF5 Aquaplast RT, Standard Perf, 2.4 mm
- RT-1778ORF5 Aquaplast RT, Micro Perf, 2.4 mm





# Pediatric ProForm Extension & Overlays



## Universal Couchtop Pediatric ProForm Extension

The Universal Couchtop Pediatric ProForm Extension self-locks onto the Universal Couchtop, allowing the thermoplastic to connect to the couchtop.

**MTIL6682K** Pediatric ProForm Head & Neck Extension, 48.7" (123.7 cm), includes Cushion Guide and UCT Patient Handles



## Pediatric ProForm Overlays

The ProForm CT & Photon Treatment Overlay and MR Overlay allow for CT simulation or MR imaging of patients who will be treated on the Universal Couchtop ProForm Extension, allowing seamless transition from simulation to treatment.

**PRO400K** Pediatric ProForm CT & Photon Treatment Overlay, 2-Pin Lok-Bar compatible, includes ProForm Cushion Guide and Patient Handles

**PRO420K** Pediatric ProForm MR Overlay, 3-Pin Lok-Bar compatible, includes ProForm Cushion Guide and Patient Handles



See pages 193-197 for the complete ProForm offering.

# Pediatric ProForm Thermoplastics



Masks on this page are disposable and sold in Qty 5. ProForm Thermoplastics are made from Aquaplast RT material.

## FreedomView IMRT Reinforced Style 18

**PRO430IM1832CL** Pediatric Head Only, 3.2 mm

**PRO431IM1832CL** Pediatric Head, Neck & Shoulders, 3.2 mm

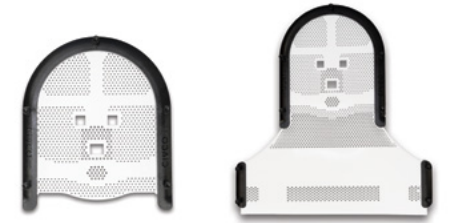

## ClearVision 2

**PRO430IM1832SG** Pediatric Head Only, 3.2 mm

**PRO431IM1832SG** Pediatric Head, Neck & Shoulders, 3.2 mm

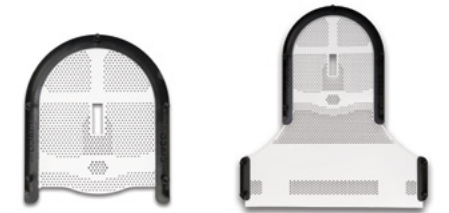

## IMRT Reinforced Style 18

**PRO430IM1832** Pediatric Head Only, 3.2 mm

**PRO431IM1832** Pediatric Head, Neck & Shoulders, 3.2 mm

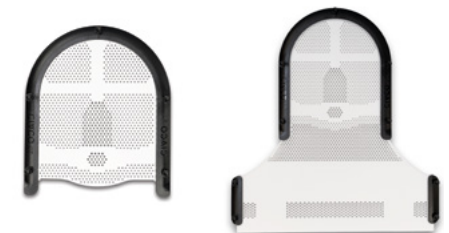

## Standard Perforated

**PRO430** Pediatric Head Only, 3.2 mm



## Registration Film

**PRO440** Pediatric, Qty 5

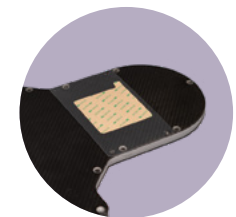

FreedomView IMRT Reinforced Style 18 Head Only



ClearVision 2 Head, Neck & Shoulders



IMRT Reinforced Style 18 Head Only



IMRT Reinforced Style 18 Head, Neck & Shoulders



Standard Perforated

# Solstat™ Immobilization System

The Solstat system is comprised of a rigid head support, customizable cushion or non-custom headrest and a dedicated thermoplastic mask designed for secure and simple attachment. These components create a highly customizable, comfortable and rigid setup for accurate head and neck treatments.

- Midline thermoplastic mask attachment provides increased rigidity and minimizes shrinkage to enhance patient comfort
- Highly conformal to the patient when using a customizable cushion and dedicated thermoplastic mask
- Unique thermoplastic frame provides easy to use, secure and quiet mask attachment
- MR Safe



## Head Support

Compatible with Type-S and Posifix Extensions, Baseplates and Overlays.

CHS05	Posifix, Qty 1
CHS06	Type-S, Qty 1

## Aquaplast RT Thermoplastics

MTAPCID1832SG	ClearVision, Standard (left photo), Qty 5
MTAPCIN1832SG	ClearVision, Narrow, Qty 5
MTAPCID1832	IMRT Reinforced, Standard (right photo), Qty 5
MTAPCIN1832	IMRT Reinforced, Narrow, Qty 5
MTAPSSTS	Shoulder, Type-S (left photo), Solid, Qty 5
MTAPSSPF	Shoulder, Posifix (right photo), Solid, Qty 5

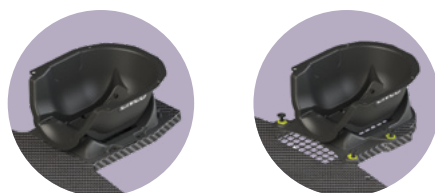

## Headrests

CHS40K	Headrest Kit (includes B, C, & F), Qty 3
CHS40	Headrest B, Black, Qty 1
CHS41	Headrest C, Black, Qty 1
CHS42	Headrest F, Black, Qty 1

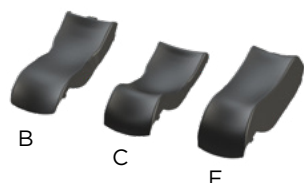

## AccuForm Cushions

MTACL2035	20 x 35 cm Chamfered, Qty 1
MTACL2035HF	20 x 35 cm Chamfered, 1/2 Fill, Qty 1



## Precise Bite

See page 105 for additional options.

MTCBPBITE	Standard, Qty 5
MTCBPBITES	Small, Qty 5



See Vision RT's compatibility statement on back cover.

# M.C.Inspire Baseplate

CO-DEVELOPED WITH MIAMI CANCER INSTITUTE

The M.C.Inspire Baseplate uniquely integrates and aligns ViewRay's MRIdian head and neck coils with the high precision positioning provided by Solstat and Solstice SRS Immobilization Systems. The acrylic baseplate features recessed receptacles that properly position and secure the posterior head and neck coil below the head immobilization system. Together, these components form an integrated system specifically designed to optimize head and neck setup, imaging and treatment with the MRIdian MRI-Guided LINAC.

- Optimized positioning of the posterior head & neck coil with a head immobilization system
- Easy and efficient transport, setup and storage of the system components on and off the couchtop
- Designed to complement MRIdian's low-field-strength magnet
- Dosimetrically accurate (calculated TPS dose compared to measured dose in the LINAC)\*

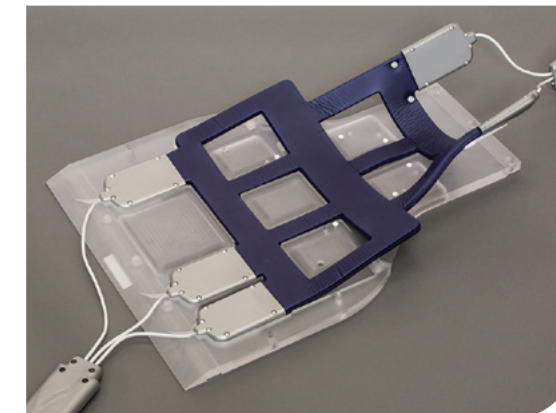

The baseplate properly positions and secures the head & neck coil below the head immobilization system.

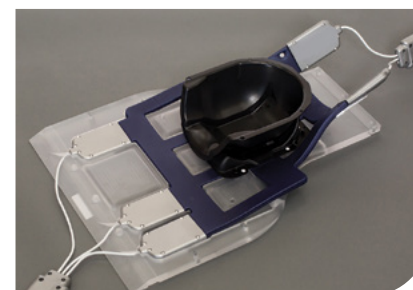

## M.C.Inspire Baseplate & Solstat Starter Kit

Kit includes: Baseplate, Three-Pin Lok-Bar, Solstat Head Support, ClearVision open-face thermoplastic masks, Standard size (x10), 20 x 35 cm Chamfered AccuForm Cushion (x10)

CHS14SGK See page 102 for Solstat product information

## M.C.Inspire Baseplate & Solstice Starter Kit

Kit includes: Baseplate, Three-Pin Lok-Bar, Solstice Glass Fiber Head Support, ClearVision open-face thermoplastic masks, Standard size (x10), 20 x 35 cm Chamfered AccuForm Cushion (x10)

CHS18MRSGK See page 63 for Solstice product information

\*Gamma index of 98.8% (3%/2 mm) obtained for a plan with 13 fields and 13 gantry angles. Performance specifications are for reference only, values may vary based on setup and equipment.



# Customizable Head Support

The Customizable Head Support is a shell and customizable cushion system. The unique shape of the shell was designed to encourage the cushion to return the patient to a repeatable position from fraction to fraction.

- Allows more support under patient's neck for less superior-inferior movement (pitch)
- Provides enhanced comfort so patient is less likely to move during treatment
- Two small pins centered inside the shell provide fixed, repeatable points while preventing the cushion from moving
- Deep "bowl" shape provides a deeper head capture than using a cushion alone or standard head supports
- Compatible with Vision RT's Align RT camera system when used with ClearVision Thermoplastic

<b>CHS01</b>	Posifix
<b>CHS02</b>	Type-S
<b>MTACL2035HF</b>	20 x 35 cm Chamfered AccuForm, 1/2 Fill
<b>MTACL2035</b>	20 x 35 cm Chamfered AccuForm

See Vision RT's compatibility statement on back cover.



Posifix with 20 x 35 cm AccuForm



Type-S with 20 x 35 cm AccuForm

# Precise Bite™

The Precise Bite attaches easily to a thermoplastic cast and conforms to the teeth and/or maxilla to aid in effective and repeatable positioning. The Precise Bite with tongue depressor assists in tongue displacement and provides an airway opening for easy breathing.

<b>MTCBPBITE</b>	Standard, Qty 5
<b>MTCBPBITETD</b>	Standard w/ Tongue Depressor, Qty 5
<b>MTCBPBITES</b>	Small, Qty 5
<b>MTCBPBITETDS</b>	Small w/ Tongue Depressor, Qty 5
<b>MTCBPBITEWRM</b>	Warmer, 110 volt

WARMER HAS NOT BEEN CE MARKED



# IntegraBite™

The IntegraBite bite plate provides repeatable positioning and decreases patient head and neck rotation, flexion, and extension. The simple and streamlined design makes application and insertion easy.

**RT-A001**

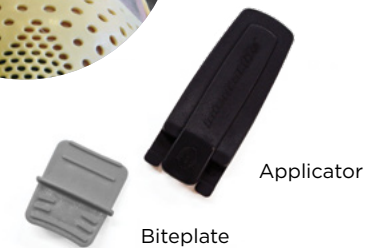

**IntegraBite™**

# GrayDuck Stent™ Oral Positioning Device

GrayDuck Stent and GrayDuck Dart are currently the only custom fitted bite block systems that can position the tongue in one of several positions; laterally (left or right), depressing (downward) or a combination thereof.

- Tongue-displacing and immobilizing oral stent
- Capable of providing repeatable tongue deviation and immobilizing in several directions
- Designed to provide repeatable immobilization and tissue sparing during radiotherapy
- Ergonomically developed to be a quick, easy-to-fit custom oral stent

<b>GDS002</b>	GrayDuck Original, Size Small, Qty 4
<b>GDS001</b>	GrayDuck Original, Size Medium, Qty 4

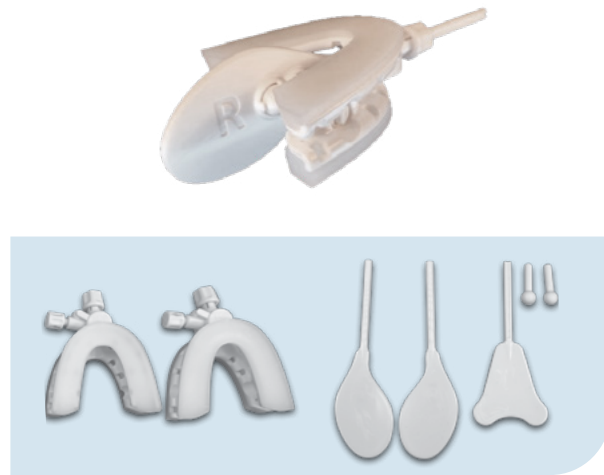

GrayDuck Stent, Original. Each Kit includes small or medium stent, 3 paddles, and 2 struts.

# GrayDuck Dart™

NEW & IMPROVED DESIGN!

The GrayDuck Dart is a new and improved version of GrayDuck Stent, offering a significantly smaller and easier-to-use stent while retaining the same level of customization as described above.

- Smaller stent size increases patient tolerance and improved insertion for patients with limited bite opening
- Three simple steps allow for faster workflow
- Spacers allow for increased bite opening, if needed
- Universal stent orientation allows placement in patient's mouth on either arch tray side

<b>GDS003</b>	GrayDuck Dart, Qty 4
---------------	----------------------

CE MARKED, 510(K) CLEARED  
US PATENT #9,504,537 AND OTHER PATENTS PENDING

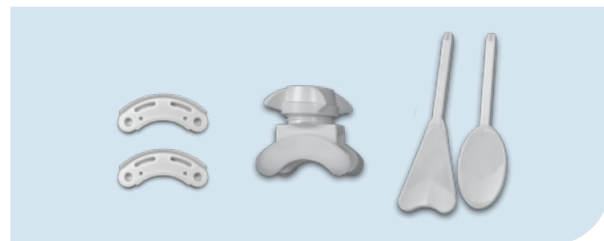

GrayDuck Dart. Each Kit includes dart stent, 2 paddles, and 2 spacers.

# AccuForm™ Cushions

AccuForm Cushions are ideal for high-precision head and neck treatments when enhanced comfort, stability and repositioning accuracy are key.

- Soft, cloth-covered pillow contains tiny beads coated in water-curable resin
- Cushion becomes pliable when sprayed with water, allowing formation around patient's contours, including custom pitch and rise
- Cushion forms a rigid, comfortable custom mold when dry
- Single patient use
- 15 x 20 cm cushion recommended when customized fit is needed on a standard headrest
- 20 x 25 cm, 20 x 45 cm and Type-S cushions can be used as stand-alone cushions
- 20 x 35 cm chamfered cushion features clipped cushion corners that provide support without interfering with the thermoplastic

<b>MTACL1520</b>	15 x 20 cm AccuForm
<b>MTACL14242</b>	20 x 25 cm AccuForm
<b>MTACL2035</b>	20 x 35 cm Chamfered
<b>MTACL2035HF</b>	20 x 35 cm Chamfered Half Fill
<b>MTACL2035U</b>	20 x 35 cm AccuForm U Shaped
<b>MTACL2045</b>	20 x 45 cm AccuForm
<b>MTACLTYPE S1</b>	Type-S AccuForm
<b>MTACL4060</b>	40 x 60 cm AccuForm
<b>MTACL5865T</b>	58 x 65 cm AccuForm Trapezoid, Head, Neck & Shoulders
<b>MTACL6060</b>	60 x 60 cm AccuForm

## AccuForm Positioner

An AccuForm Positioner can be used for indexing an AccuForm cushion to Uni-frame and Type-S baseplates.

<b>MTACL001</b>	
-----------------	--

## AccuForm Shim

The AccuForm Shim is a flexible, thin foam piece that provides a small height offset above the customized patient AccuForm. The shim is intended to be placed onto the formed AccuForm cushion, and prior to forming the thermoplastic mask.

Using the shim can counteract suspected mask shrinkage and/or patient swelling, increasing patient comfort while maintaining ideal immobilization.

<b>MTACL SHIM</b>	Qty 10
-------------------	--------



15 x 20 AccuForm

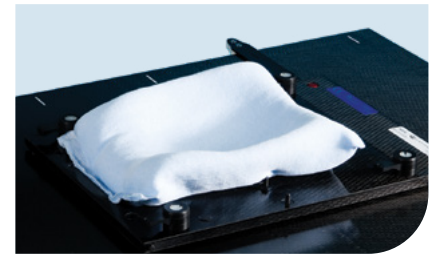

20 x 25 AccuForm



Type-S AccuForm

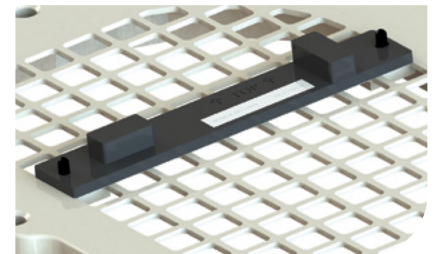

AccuForm Positioner



AccuForm Shim



# Individual Head Support

The Individual Head Support provides customized head and neck positioning during radiation therapy treatment and diagnostic procedures. This head support assists in maximizing fixation, stability and comfort while minimizing longitudinal, lateral and rotational movement of the patient.

- Made from a specially shaped impression foam combined with fabric-coated thermoplastic
- Gives clinicians the power to customize position and support to each patient
- Can be used with traditional thermoplastic masks, as well as more rigid head frames to deliver stereotactic radiation therapy and radiosurgery
- Available for use with Posifix extensions, baseplates and overlays

MTIHS01	Posifix, Natural Position
MTIHS02	Posifix, Hyperextension

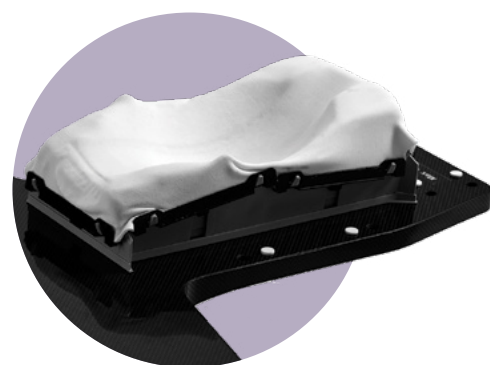

# Shoulder Retractor

The Shoulder Retractor is often used with thermoplastic-based fixation systems. Retraction is especially beneficial for shoulder clearance when opposing lateral fields are used to treat the neck.

- Constructed of durable plastic with a large footboard and nylon tension ropes with ball-in-socket locking, allowing for selectable tension in 1/2" increments
- Available with Handle Grips, Sherpa Wrist Loops or washable Nylon Wrist Loops

MTSR01	Retractor with Handle Grips (left photo)
MTSR02	Retractor with Sherpa Wrist Loops (middle photo)
MTSR03	Retractor with Nylon Wrist Loops (right photo)



# Headrests

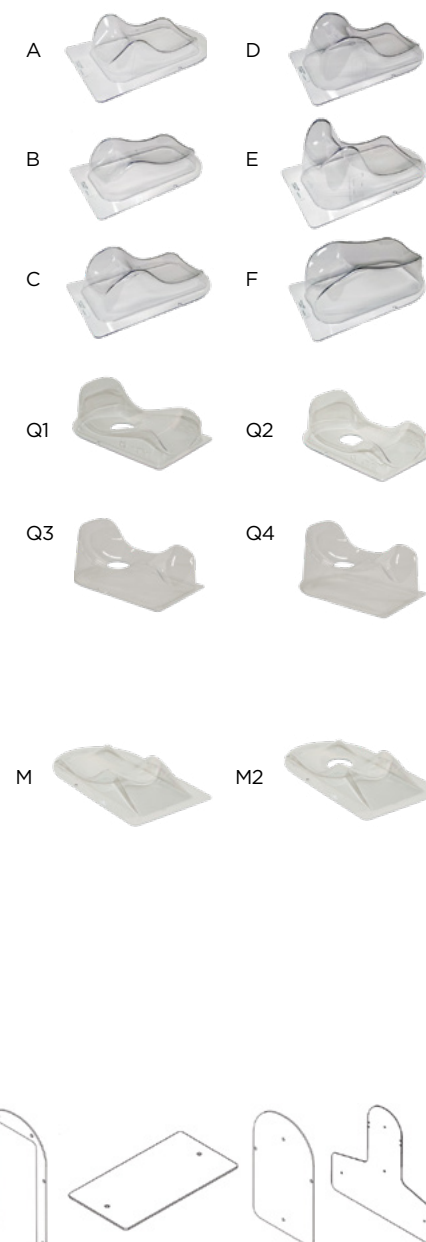

## Silverman Headrests

With a Silverman, no transmission correction is necessary for most high-energy beams. Silverman headrests can be purchased individually or in a set of six.

The Silverman Q1 and Q2 minimize overstretching of the mask while simultaneously offering cranial support.

MTSILVER2A / RT-4491R2-A	A
MTSILVER2B / RT-4491R2-B	B
MTSILVER2C / RT-4491R2-C	C
MTSILVER2D / RT-4491R2-D	D
MTSILVER2E / RT-4491R2-E	E
MTSILVER2F / RT-4491R2-F	F
MTSILVER2 / RT-4491R2	Set of six, sizes A-F
RT-4491-Q1	Q1
RT-4491-Q2	Q2
RT-4491-Q3-2G	Q3
RT-4491-Q4-2G	Q4

## Low-Profile Silverman Headrests

For the Silverman 'M' and 'M2', the exclusive low-profile design allows the occiput to rest below the top plane of the board. By lowering the patient's head, the mask is stretched a shorter distance during the molding process. Less stretch means a more comfortable mask and an overall better fit for the patient.

RT-4491R-M	M
RT-4491R-M2	M2

## Shims

Shims are for use with headrests and systems.

MTSHIMS	Silverman
MTSHIMT	Timo
MTSHIM01	Type-S Head Only
MTSHIM01S	Type-S Head, Neck & Shoulders

Headrest shape may have slight variations; the same headrest should be used for a patient throughout setup and treatment cycle.

# Headrests

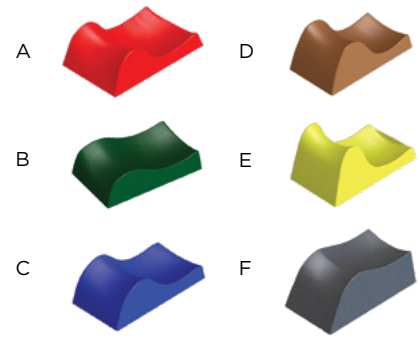

Colors received may vary from photo and description.

## Timo Headrests

Timo headrests are constructed of durable polyurethane foam with a washable coating. Six various heights and contours offer a comprehensive range of neck angulations. They are available plain or with Lexan plates for use with Uni-frame baseplates and Wing Boards.

Add "L" to any "MT" part number to add Lexan Plate.

MTTIMOA / RT-4490-A	A, Red
MTTIMOB / RT-4490-B	B, Green
MTTIMOC / RT-4490-C	C, Blue
MTTIMOD / RT-4490-D	D, Brown
MTTIMOE / RT-4490-E	E, Yellow
MTTIMOF / RT-4490-F	F, Gray
MTTIMO / RT-4490	Set of six
MTTIMOL	Set of six w/ Lexan Plates

## Extended Head Stop Headrests

The Extended Head Stop Headrests help encourage patients to return closer to the same position from treatment to treatment by providing a cranial stop as a reference for where to place their head.

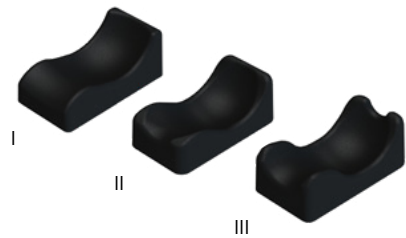

301030	I, Large
301032	II, Medium
301033	III, Small
301034	Set of three

## Posifix Supine Headrests

Posifix headrests are made of low density polyethylene foam.

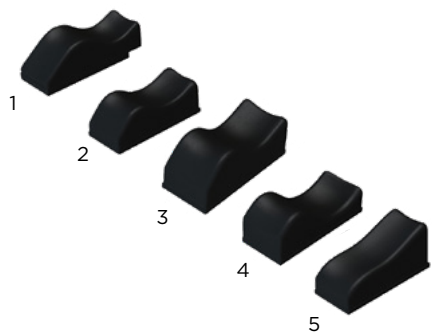

301201	1, Similar to #2 with patient shift in superior direction
301202	2, Natural position
301203	3, Slightly hyperextended
301204	4, Hyperextended
301205	5, Chin down toward chest
305001	Set of five

Headrest shape may have slight variations; the same headrest should be used for a patient throughout setup and treatment cycle.

# Headrests



## Posifix Contoured Headrests

The Posifix Contoured Headrests feature colored bottoms for easy identification and are wider and higher than the standard Posifix supine headrests, completely surrounding the back of the head. This design is intended to encourage less lateral, longitudinal and rotational movement during setup and treatment.

301023	Yellow bottom, Slightly hyperextended
301024	White bottom, Hyperextended
301022	Orange bottom, Natural position
301234	Set of three

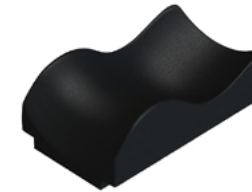

## Posifix Wide Headrest

A special wide headrest, made of low density polyethylene foam, is available in a natural position design.

301008A



## Posifix Prone Headrest

The Prone Headrest is specially designed for treatments with the patient in the prone position. The 3-D shaped contour supports chin and forehead and therefore, assists in creating a reproducible and comfortable position.

301025BLK



## Posifix Pediatric Headrests

Designed for use with pediatric patients. Both the prone and supine headrests are available in bright, glossy colors.

301026	Supine
301027A	Prone

Headrest shape may have slight variations; the same headrest should be used for a patient throughout setup and treatment cycle.



# Headrests



## Prone Head Cushion & Adapter

Designed to support the patient's head while in the prone position. The contoured shape supports the chin and forehead providing comfortable and reproducible positioning. The Head Cushion Adapter allows the Prone Head Cushion to be mounted to any device that uses Silverman locating pins.

**RT-4552P** Prone Head Cushion (shown on Head Cushion Adapter that is sold separately)

**RT-4552A** Head Cushion Adapter for Silverman Pins

Headrest shape may have slight variations; the same headrest should be used for a patient throughout setup and treatment cycle.

# Spacers & Wedges

Spacers & Wedges are available in a variety of heights and angles for use with the Posifix Patient Positioning System to provide positioning offset of the patient for unique treatment needs. They can accommodate the use of all Posifix style headrests, Extended Stop Headrest, Posifix Customizable Head Support and Posifix Individual Head Support.

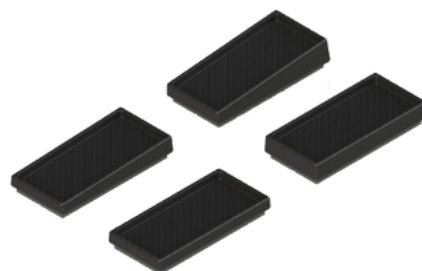

<b>107101</b>	Wedge, 2.5°
<b>107102</b>	Wedge, 5°
<b>107103</b>	Spacer, 20 mm
<b>107104</b>	Spacer, 30 mm
<b>107106</b>	Spacers & Wedges. Set of four includes: Wedges 2.5° and 5°, Spacers 20 and 30 mm

# Direct Indexing™ Adapters

REQUIRED WHEN EXTENDING A STANDALONE DEVICE BEYOND THE END OF THE COUCHTOP:



**RT-4527EXA**  
Varian Exact IGRT Couchtop  
(Two hand grip posts included)



**RT-4527LMI3**  
Elekta/Medical Intelligence I-Beam and Tomotherapy  
(Two hand grip posts included)



**RT-4527QFIX**  
CQ Medical kVue & QUANTUM



**RT-4527EXAG**  
Varian Exact Couchtop

FOR ATTACHING A STANDALONE DEVICE TO CT OVERLAYS:



**RT-4529M**  
Varian Exact compatible CT  
(4 black discs included)



**RT-4527QFIX**  
CQ Medical kVue & QUANTUM



**RT-4527LTOMO**  
Tomotherapy Adapter

# Adapters



301035  
MR Posi-S Adapter\*



301029  
MR Posi-S Adapter with Backplate\*

\*The 301035 and 301029 do not provide equivalent setups. Customers using 301029 should reorder that part number. New customers should order 301035.

## Headrest Adapters

Headrests provide enhanced repositioning, accuracy and patient comfort. Many headrests are compatible with our three head & neck patient positioning systems (Type-S, Posifix or Uni-frame) and Wing Boards directly or via an adapter.

301035*	MR Posi-S Adapter
301029*	MR Posi-S Adapter with Backplate

# RapidHeat™ Oven

## RAPIDHEAT HOT AIR OVEN FOR THERMOPLASTIC MASKS, SHEETS, BOLUS, AND PELLETS

Quickly reaches working temperatures and provides an easy-to-use method to heat thermoplastic masks as well as Aquaplast RT Custom Bolus. Its unique two fan design and optimal spacing between racks allows the hot air to soften the thermoplastic quickly and evenly. RapidHeat has a large 75 mm high digital display that features a Quick Start Guide to easily navigate operating the oven. The digital temperature controller can be used in a programmable or manual timer mode, increasing workflow efficiencies.

- Easily preheat the oven while prepping the patient
- Digital timer counts down from the designated time and alerts when ready
- Minimizes cross contamination
- Non-stick ball-bearing sliding racks for easy cleaning and removal of masks

Dimensions (W x D x H)  
Overall: 32 x 30 x 19.1" (81.3 x 76.2 x 48.5 cm)  
Internal: 27 x 21 x 10" (68.6 x 53.3 x 25.4 cm)

RT-2075-110	RapidHeat Oven, 110 Volts
RT-2075-220*	RapidHeat Oven, 220 Volts

\* Comes standard with European plug.

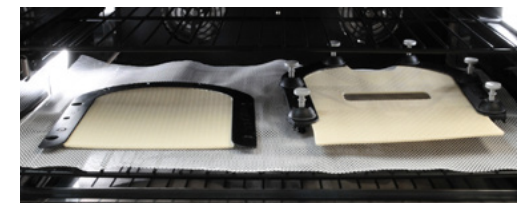

RapidHeat™ Oven

# Water Bath & Warmer

## Water Bath

The Water Bath accommodates all thermoplastic sizes including Type-S head, neck and shoulders, HipFix, and ThermFix thermoplastics.

Dimensions (W x D x H)\*  
Overall: 31.25 x 24 x 13" (79.37 x 60.96 x 33.02 cm)  
Internal: 25 x 19 x 5" (63.5 x 48.3 x 12.7 cm)



MTRH1500	120V
MTRH1500EX	230V
MTCBPLLG	Pan Liner, Large, Qty 2

\*Dimensions do not include shut off valve mounted on side.

## Water Bath Cart

The Water Bath Cart provides an easy, efficient way to transfer a water bath between treatment rooms. Load capacity 500 lbs (227 kg).

Dimensions (W x D x H, height includes handle)  
Overall: 25.5 x 43 x 38" (64.8 x 109.2 x 96.5 cm)



MTMC01003
-----------

## Precise Bite Warmer

The Precise Bite Warmer softens a Precise Bite, GrayDuck Stent, or GrayDuck Dart without a microwave or water bath.

See page 66 for more information

MTCBPBITEWRM	Warmer, 110 volt
--------------	------------------

CONTACT YOUR SALES REPRESENTATIVE FOR COUNTRY COMPATIBILITY. THIS PRODUCT HAS NOT BEEN CE MARKED.







**CONSIDER  
THIS:**

A goldfish may have  
a longer attention  
span than a patient.

Let's face it, it's hard for patients to stay focused during radiation. That's why we do everything we can to make positioning equipment that makes them more comfortable, more relaxed, and secured in place. That's *our* focus.

 **CQ MEDICAL™**  
Care Smarter  
Formerly CIVCO RT™ and Qfix®

# Breast & Thorax



122  
C-QUAL M & C-QUAL  
BREASTBOARD

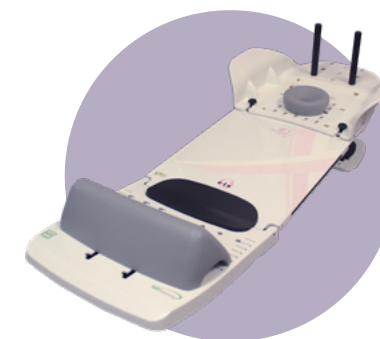

125  
ACCESS SUPINE DEVICES



129  
EVOLVE  
BREASTBOARD

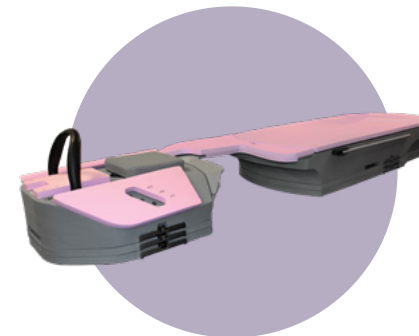

133  
ACCESS 360 G2 PRONE  
BREAST INSERT & DEVICE

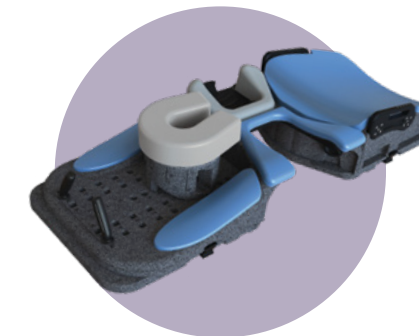

135  
NEW HORIZON PRONE  
BREASTBOARD



136  
WING BOARDS

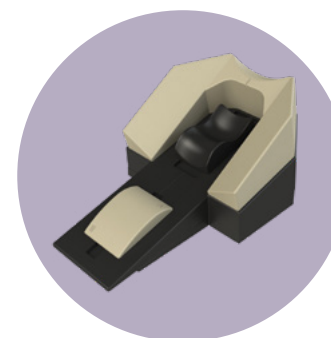

137  
THORAWEDGE



154 & 156  
VACUUM CUSHIONS



# CHOOSING A SUPINE BREAST & THORAX POSITIONING SYSTEM\*



## C-Qual M™ C-Qual™

Page 122

Page 124

<b>ARM &amp; HAND SUPPORT OPTIONS</b>	Monarch Overhead Arm Positioner	Arm & Wrist Supports, Monarch Overhead Arm Positioner
<b>HAND GRIP OPTIONS</b>	M Handle, Individual Hand Grips	M Handle, Individual Hand Grips
<b>TREATMENT COMPATIBLE</b>	Photon, Proton	Photon
<b>IMAGING COMPATIBLE</b>	CT, MR	CT
<b>BACK BOARD MATERIAL</b>	Kevlar, Foam Core	Carbon Fiber
<b>ELEVATION SUPPORTS</b>	5°-25° (nine indexable tilt positions)	5°-25° (nine indexable tilt positions)
<b>HEAD SUPPORT OPTIONS</b>	Posifix® Headrests	Posifix Headrests
<b>BREAST THERMOPLASTICS</b>	Yes (one indexing position)	Yes (one indexing position)
<b>HEAD THERMOPLASTICS</b>	Yes (Posicast Head Only and Chin Strap)	Yes (Posicast Head Only and Chin Strap)
<b>VAC-LOK OPTION</b>	Yes	Yes
<b>BACK BOARD ATTENUATION</b>	3.7% @ 6MV (back support & base)	3.11% @ 6MV (back support & base)
<b>CLEAR SUPRACLAV REGION</b>	Yes	Yes
<b>BOTTOM BOARD</b>	Permanent	Permanent

## Access™ MR Access™ Evolve®

Pages 125-128

Pages 125-128

Page 129

<b>ARM &amp; HAND SUPPORT OPTIONS</b>	Arm & Wrist Supports, ArmShuttle Elite (interchangeable)	Arm & Wrist Supports, ArmShuttle Elite (interchangeable)	Pro, Extended or Standard Wing Boards, Monarch Overhead Arm Positioner
<b>HAND GRIP OPTIONS</b>	ArmShuttle Posts	ArmShuttle Posts	T-Handle, U-Handle, Pro Handles, M Handle, Delrin Handles
<b>TREATMENT COMPATIBLE</b>	Photon	Photon	Photon
<b>IMAGING COMPATIBLE</b>	CT, MR	CT	CT, MR
<b>BACK BOARD MATERIAL</b>	Foam Core Composite	Carbon Fiber	Glass Fiber, Foam Core
<b>ELEVATION SUPPORTS</b>	0°-25° (eight indexable tilt positions)	0°-25° (eight indexable tilt positions)	5°-15° (five indexable tilt positions)
<b>HEAD SUPPORT OPTIONS</b>	Foam, Gel Cup, TIMO B Headrest, Silverman	Foam, Gel Cup, TIMO B Headrest, Silverman	Round Foam, Gel Cup, Silverman, Timo w/ Lexan plate or adapter
<b>BREAST THERMOPLASTICS</b>	Yes (one indexing position)	Yes (one indexing position)	Yes (two indexing positions)
<b>HEAD THERMOPLASTICS</b>	Yes (Type-S Chin Strap, Head Only and Head, Neck & Shoulders)	Yes (Type-S Chin Strap, Head Only and Head, Neck & Shoulders)	Yes (Chin Strap)
<b>VAC-LOK OPTION</b>	Yes	Yes	Yes
<b>BACK BOARD ATTENUATION</b>	Contact Sales Manager	Contact Sales Manager	2.36% @ 6MV
<b>CLEAR SUPRACLAV REGION</b>	Yes	Yes	Yes
<b>BOTTOM BOARD</b>	Permanent	Permanent	Optional

\*These breastboards offer many configurations and compatibilities. Please consult your sales representative for more information.

# C-Qual M with Monarch™ Overhead Arm Positioner



C-Qual M™ Breastboard Monarch™ Overhead Arm Positioner

The C-Qual M Breastboard features integration with the Monarch Overhead Arm Positioner, providing an efficient approach for arms-up positioning and allowing proper superior/inferior adjustment of the board to the patient which helps reduce patient slide.

- Matches body contours for optimal arm support and patient comfort
- Contoured cutouts in shoulder region help reduce attenuation during posterior axillary boosts
- Two hand grip designs allow for customized placement of each hand and arm
- Easy on/off latch system of the Monarch Overhead Arm Positioner eliminates need for tools to make adjustments
- Optical Surface Monitoring System (OSMS) compatible
- Elevation Supports secure angles from 5° to 25° with nine different tilt positions
- Compatible with Posicast Head Only and Chin Strap Thermoplastics (with Monarch or board-only), Breast Support Thermoplastics, Posifix Headrests and Vac-Lok Cushions

## MTM400 C-Qual M with Monarch

Wall Storage device available, see page 212

### Breast Support Thermoplastic

These thermoplastics for breast positioning require two reusable handles that mount to the C-Qual M, C-Qual, Evolve Breastboards.

	2.4 MM	3.2 MM	
Standard Perforated	MTRFX9182.4	MTRFX918	
IMRT Reinforced	MTRFI9182.4	MTRFI918	
Breast Support Handle System, Qty 2	-	-	MTRFH3



Featuring Individual Hand Grips



Mask can attach directly to incline board



# Monarch Overhead Arm Positioner

The Monarch Overhead Arm Positioner is 23.4" (59 cm) wide and features two hand grip designs; a one-piece M Handle or individual hand grips. Each option can be adjusted a total of 24 cm and the individual grips can adjust in 2.2 cm increments for customized placement of each hand/arm.

- Matches body contours for optimal arm support and patient comfort
- Indexable for easy stand-alone use
- Compatible with Posicast Head Only and Chin Strap Thermoplastics with use of Monarch Thermoplastic Frame

OAP110	Monarch (includes M Handle, Tracks and Headrest)
OAP221	Pro Individual Hand Grips, Qty 1
OAP170	M Handle Tracks (2 each) (for Monarchs purchased prior to January 2019)
OAP180	Individual Hand Grips (2 each) and Tracks (set of 2) (for existing Monarch customers prior to January 2019)

### Thermoplastic Option

Posicast thermoplastics are drape-style masks that require less stretching, therefore resulting in minimal shrinkage after cooling.

OAP120	Monarch Thermoplastic Frame
970031	Posicast-Lite Head Only (3 pt) with Open-face, 2.3 mm, Qty 10
772021	Chin Strap Thermoplastic, Qty 10

### Wing Board Vac-Lok

Wing Board Vac-Lok creates a rigid and secure support around the patient when a vacuum is drawn through a self-sealing quick-release valve. See page 154 for more information.

VLWGB04C	108 x 55 cm, 17 L, Nylon (also compatible with Pro Wing Board)
VLWGB05C	108 x 55 cm, 14 L, Nylon w/ Head Support Cutout



Monarch™ Overhead Arm Positioner



Monarch Thermoplastic Frame allows for attachment of Posicast Head Only or Chin Strap Thermoplastics



Monarch with 108 x 55 cm Wing Board Vac-Lok



# C-Qual Breastboard

The carbon fiber C-Qual Breastboard is lightweight, designed for patient comfort and features a low-attenuating IGRT treatment zone. The C-Qual's advanced features bring efficiencies to breast setup and treatment.

- Elevation Supports secure angles from 5° to 25° with nine different tilt positions
- Advanced arm supports, with no interference in the supraclavicular region
- Compatible with the Monarch Overhead Arm Positioner
- Compatible with Posicast Head Only Thermoplastics (page 97) and Breast Support Thermoplastics (page 122)
- Special wide headrest included

<b>MT401</b>	C-Qual with Monarch. Includes M Handle and Tracks compatible with the Individual Hand Grips (hand grips sold separately).
<b>MT400</b>	C-Qual with Arm & Wrist Supports
<b>OAP100</b>	Monarch (upgrade kit for MT400). Includes M Handle and Tracks compatible with the Individual Hand Grips (hand grips sold separately).
<b>OAP120</b>	Monarch Thermoplastic Frame

Wall Storage device available, see page 212  
 Monarch Individual Hand Grip options available, see page 123



# Access Supine & Access Supine MR

The Access Supine positions the patient's chest and thorax for external beam radiotherapy. The ladder system secures the backrest at various angles while the tailbone pad and bottom stopper comfortably support the patient for the duration of imaging and treatment.

- Accessories fix securely to the device so that they remain in place for storage and workflow efficiency
- Ladder system indexes patients at 0°, 5°, 7.5°, 10°, 12.5°, and 15° angles for breast treatments
- Optional 20° and 25° ladder set sold separately

<b>RT-4546MRI</b>	Access Supine MR Breast & Lung
<b>RT-4546</b>	Access Supine Breast & Lung with Carbon Fiber Grid
<b>RT-4546-02</b>	Access Supine Breast & Lung without Carbon Fiber Grid
<b>RT-4546-01</b>	Access Supine Breast Only with X-Trans™ base

Access Wall Mount available, see page 212

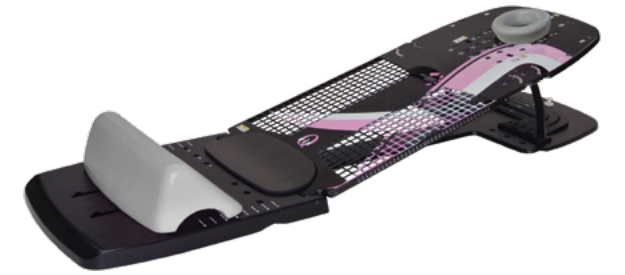

Foam bottom stopper and headrest Included. Arm Support Options sold separately, see page 126.



Built-In Ladder System Included. Accessory Ladder Set Sold Separately.



Indexing Scale on device

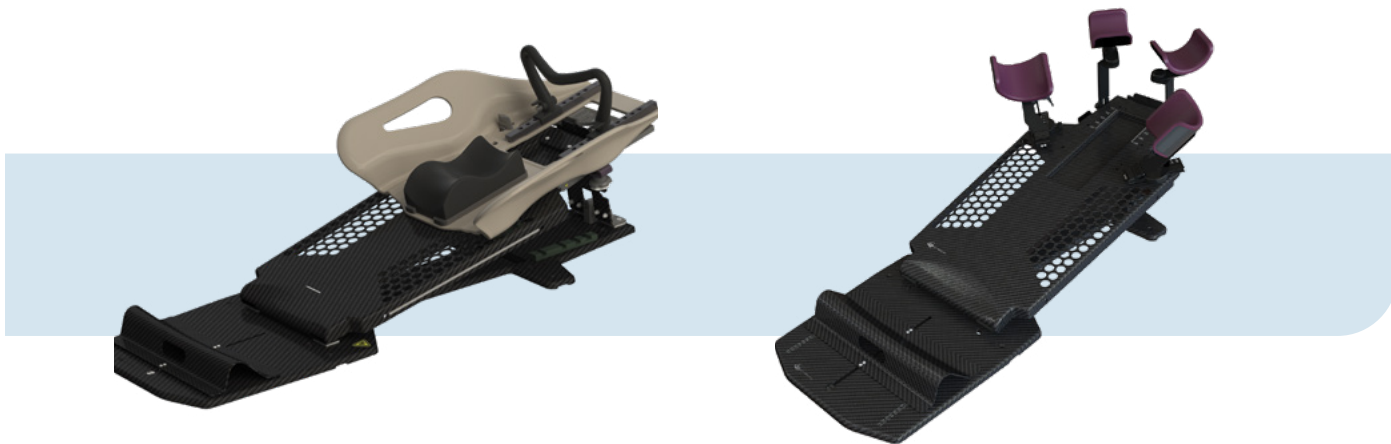

C-Qual with Monarch Overhead Arm Positioner

C-Qual with Arm & Wrist Supports



MR Safe with ArmShuttle Elite

With Carbon Fiber Grid with Arm & Wrist Supports

Without Carbon Fiber Grid with Arm & Wrist Supports

With X-Trans Base with Arm & Wrist Supports

## Access Supine Arm Support Options



### ArmShuttle™ Elite

The ArmShuttle Elite allows for full arms up positioning technique. The ribs of the shuttle index vacuum cushions and aid in ease of setup for daily treatments. The ArmShuttle Elite can affix to Access MR and Access Supine devices. It is possible to index directly to treatment couch tops for standalone use.

RT-4546C	ArmShuttle Elite with foam headrest and posts (w/ no indexing scales) (bottom-left photo)
RT-8003020	ArmShuttle Post with Indexing Scale, 1 Post (sold separately) (bottom-right photo)



### Arm & Wrist Supports

Independently adjustable Arm & Wrist Supports position the patient's arms out of the treatment field while exposing the chest for breast and nodal imaging and treatment. The ability to customize each patient's arm and wrist position also helps to increase comfort for patients with incisions while minimizing skin folds.

- Turn knob allows quick and ridged indexing of the Arm Support
- Wrist Supports rotate and are height adjustable
- Pads are easily removed for cleaning

RT-4546AW-01	Access Wrist Support (left photo)
RT-4546AA-01	Access Arm Support (right photo)



## Access Supine Customization



### Portrait Head & Shoulder Thermoplastic Adapters

Portrait Head & Shoulder thermoplastic adapters allow head and neck treatment for patients that are unable to lie flat. Portrait Head Only Adapter is supplied with mounting provisions for a chin strap.

RT-4546-03	Portrait Head Only Adapter (left photo)
RT-4546-04	Portrait Head & Shoulder Adapter (right photo)



### Thermoplastic Chin Strap

Aquaplast RT Thermoplastic Chin Strap is designed to be used with the Portrait Head Only Adapter for Access Supine Breast Devices to keep the patient's head out of the treatment field.

RT-1778PR2DC	Aquaplast RT Chin Strap
--------------	-------------------------



### Thermoplastic Breast Adapter

This device increases functionality by providing the ability to attach thermoplastic sheets to the Access Supine. This increases reproducibility of breast positioning for treatment. The device works in conjunction with 14" Opti-Handles to secure thermoplastics to the Access Supine.

RT-4546-05	Access Supine Thermoplastic Breast Adapter
RT-4454-14	Opti-Handles, 36 cm (14 in.)
RT-1783P3	Aquaplast Standard Perf (30 cm x 45 cm x 2.4 mm)



## Access Supine Customization



Accessory Ladder securely attaches to mount on the baseplate

### Accessory Ladder Set

Accessory Ladder Set elevates the backrest to 20° & 25° angles for increased imaging and treatment options.

RT-4546L      Accessory Ladder Set



ArmShuttle Elite with Adapter and Silverman headrest

### Silverman Adapter for Breast Devices & ArmShuttle

Easily indexes Silverman headrest for enhanced repositioning, accuracy, and patient comfort.

RT-4543S      Silverman Adapter for Access Breast Devices & ArmShuttle (Note: Silverman Adapter is transparent)

### Headrests

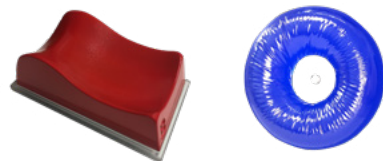

RT-4490-BX      TIMO B Headrest with Indexing Tray (left photo)

RT-4494      Gel Donut, 200mm (right photo)

RT4494-P      Gel Donut, 150mm

## Evolve Breastboard

The Evolve Breastboard is a lightweight solution that allows quick and simple indexing of many Wing Boards which aids in reproducibility without sacrificing patient comfort. Many hand grips, headrests, and thermoplastic options easily integrate to maximize positioning options based on patient or clinical need.

- CT, MR, photon and SGRT treatment compatible
- Indexing marks allow reproducible setup
- Side scales assist with alignment
- Compatible with Breast Support Thermoplastics (page 122) and Wing Board Vac-Lok Cushions (page 154)
- Indexable to TotalRT Platform or other couchtops via two- or three-pin Lok-Bar
- Indexable with or without the optional bottom board



Evolve  
Breastboard

### SIMPLE ELEVATION ADJUSTMENT

Support bar secures the board from 5° to 15° with five adjustable elevation angles. Simply lift the superior end of the board and push the handle to adjust the elevation.

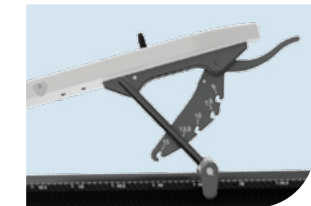

### INTEGRATED GLIDETRACK

Allows simple positioning of the Pro, Extended and Standard Wing Boards to accommodate patients of varied torso lengths.



### A MODULAR APPROACH TO BREAST & THORAX POSITIONING



Evolve with Pro Wingboard

Evolve with Extended Wingboard

Evolve with Standard Wing Board and no Bottom Stop

# Pro Wing Board

The Pro Wing Board is 23.4" (59 cm) wide and features Individual Hand Grips that are easily adjustable 24 cm on a track in 2.2 cm increments for customized placement of each hand/arm. Two headrest options (Round Foam or Gel Cup) are indexable in eight positions

- Contoured cutouts in shoulder region eliminate attenuation during posterior axillary boosts
- Four handle options can be used (Pro Handles, M Handle, T or U Grip)
- Chin thermoplastic can attach to position patient's chin away from the beam
- Three-pin indexable for stand-alone use



OAP220 Pro Wing Board with Pro Handles and Gel Head Rest

## Pro Wing Board Accessories



OAP140  
M Handle



OAP223  
T-Grip & Track



OAP224  
U-Grip & Track



772021  
Chin Thermoplastic,  
Qty 10



MT250SUB11  
Round Head Cup

## CREATE YOUR BREASTBOARD SETUP

### Evolve Breastboard Package

MTM500 Includes Slant Board, Bottom Board, Bottom Stop, Pro Wing Board, Pro Handles and Gel Head Cup

### Evolve Slant Board, Bottom Board & Bottom Stop

OAP240

### Evolve Slant Board

OAP200

### Evolve Type-S Locating Kit

OAP300 Includes Evolve Type-S Locating Bar and Slide Guide Three-Pin Lok-Bar for indexing to Alta or TotalRT All in One

See page 136 for additional Wing Board options.



# kVue™ Access 360 G2 Prone Breast Insert

## NEAR 360 DEGREE TREATMENT ACCESS

Designed to allow breast cancer treatment for both left and right breast, including whole breast, partial breast and accelerated breast treatments. The sleek, cantilevered design provides both oblique and non-coplanar access, potentially enabling higher dose per fraction. Since the beam path is primarily through the breast with minimal couchtop interference, artifacts and scattering may be minimized.



## EXPANDED SUPRACLAVICULAR ACCESS

The thinner, wider grid window provides full access to treat the supraclavicular nodes. The supraclavicular access allows patient treatment in one setup if desired.



## kVue Access 360 G2 Package

RT-4544KV-10 Includes Left & Right Inserts, Prone Headrest, Contour Headrest, 2 Hand Grip Posts, Dual Hand Grip, CT Risers, CT Shims, Storage Cart

RT-4544KV Access 360 G2 Treatment Room Extender Package (without CT Risers and Shims)

See page 158 for Prone Breast VacQfix Cushions



Left & Right Inserts

Prone Headrest

Contour Headrest

2 Hand Grip Posts

Dual Hand Grip

CT risers and 2 CT shims

Storage Cart



## Features & Benefits of kVue Access 360 G2

### CT SIMULATION

- 130 mm CT risers index to existing overlays with 2-pin locating bars
- 25 mm CT shims attach to the CT risers to raise the insert
- Rigid, lightweight CT risers are coated for easy cleaning

### ALIGNMENT

- Virtual Indexing provides confirmation of patient alignment
- Ipsilateral scale provides an additional point of reference for laser alignment
- Knee alignment marks aid in patient positioning for daily setup

### SUPRACLAVICULAR ACCESS

- Thin, wide-grid window provides full access for treatment of the supraclavicular nodes. (Exclusively available on the kVue Access 360 G2)
- Treatment of breast and supraclavicular nodes can be accomplished in one setup

### OPEN ACCESS TREATMENT

- Breast cutout offers ability to treat with non-coplanar and oblique angles

### ADDITIONAL ATTRIBUTES

- Inverted wing design flattens the back to position breast tissue away from chest wall and torso
- Ergonomic Dual Hand Grip relieves stress on patient's wrist
- Hand Grip Posts provide a hand hold for patients with limited mobility
- Prone headrest design allows free breathing while lateral light slots promote an open feeling for claustrophobic or anxious patients
- Contour headrest allows the patient's head to be rotated to either side

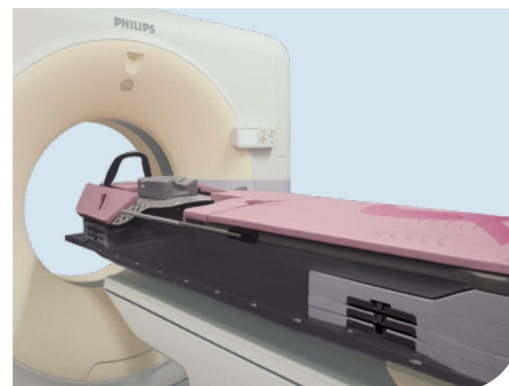

CT Simulation



Ipsilateral Scale

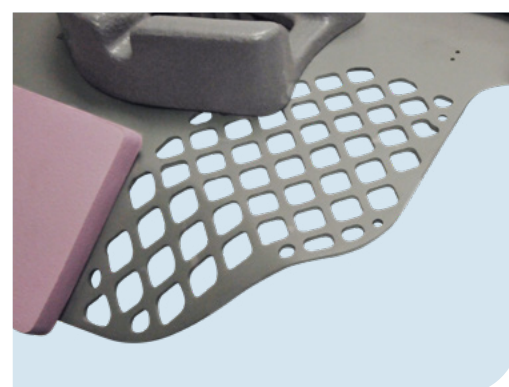

Supraclavicular Access

## Access Prone G2 Breast Device

MR Safe and CT compatible to guide patients seamlessly from simulation through treatment. The lightweight construction of the Access Prone G2 makes it easy to set up. Foam padding increases patient comfort and a removable insert can be positioned for either left or right breast treatment. The easily interchangeable inserts provide flexibility to quickly change setups for treatment. These low-attenuating inserts have superior dosimetric profiles, which minimize skin reactions.

Length: 2125 mm (83.66")

**RT-4544-01** Includes Prone Headrest, Contour Headrest, Left & Right Inserts, 2 Hand Grip Posts, Dual Hand Grip, CT Risers, 2 Sets of Shims, Storage Compartment



### ACCESS PRONE G2 ACCESSORIES



Prone Headrest

Contour Headrest

2 Hand Grip Posts

Dual Hand Grip

Convenient Storage Compartment

Left & Right Breast Inserts

2 Sets of Shims

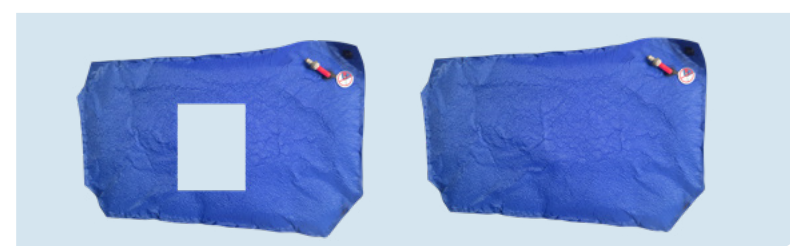

See page 158 for Prone Breast VacQfix Cushions

## Features & Benefits of Access Prone G2

### MR & CT SIMULATION

- Device allows seamless transition from simulation through treatment
- Incremental 25 mm shims allow variable height for patient setups

### ALIGNMENT

- Ipsilateral scale provides an additional point of reference for laser alignment
- Knee alignment marks aid in daily patient setup

### OPEN ACCESS TREATMENT

- Breast cutout allows treatment with non-coplanar and oblique angles

### ADDITIONAL ATTRIBUTES

- Designed for patient comfort
- Internal hand grip accessory compartments for easy, convenient storage
- Easy setup for workflow efficiency
- Prone headrest promotes free breathing
- Contour headrest allows the patient's head to be rotated to either side
- Inverted wing design flattens the back to position breast tissue away from chest wall and torso



Convenient Storage Compartment

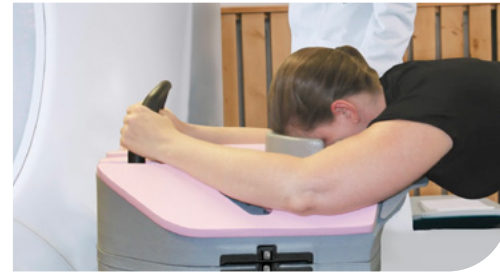

CT Simulation



Shims



Ipsilateral Scale

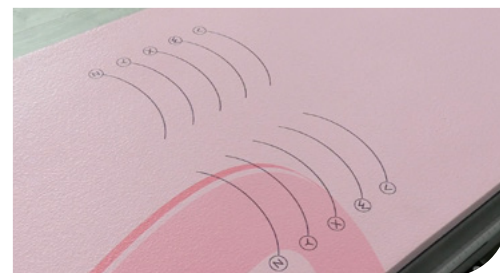

Knee Alignment Marks



Inverted Wing Design

## New Horizon™ Prone Breastboard

The New Horizon Prone Breastboard assists in providing accessible, comfortable, and reproducible patient positioning for prone breast treatments. The modular design and variety of accessories provide options for many prone breast setup challenges, allowing customized patient setups and meeting clinical needs for treatment.

- Solid and open contralateral wedges provided to meet individual patient needs
- Patient-friendly design, with contoured foam and an adjustable massage-style face cushion
- Indexable to the couchtop, assuring its orientation to lasers and isocenter is repeatable and known
- Scale rulers allow for easy verification of the longitudinal and lateral position of the patient
- Overall height can be adjusted through the use of 3 cm spacers
- Reversible breast section allows for treatment of either breast with a simple 180° turn
- Three simple-to-separate parts allow for a lighter board and easier storage and transport between treatment rooms
- The unique curved board rises to meet the patient halfway for less climbing and safe positioning



New Horizon™  
Prone Breastboard



MTHPBB01	New Horizon
MTHPBB01K	New Horizon with Type 1B Bridge and Clam-Lok Cushion
MTHPBB103	Head Cushion Covers, Qty 50





# Wing Boards™



## Extended Wing Board

The Extended Wing Board is 22.5" (57 cm) wide, constructed of durable, lightweight ABS and can be used with a T- or U-Grip handle. Its extended length allows for additional arm positioning flexibility. It is CT and MR Safe and indexable for enhanced reproducibility from imaging through treatment. It easily attaches to the Evolve breastboard.

MTWB08T	w/ T-Grip (shown)
MTWB08U	w/ U-Grip



## Standard Wing Board

The Standard Wing Board is 22.5" (57 cm) wide, constructed of durable, lightweight ABS and features Delrin post hand grips. It is CT and MR Safe and indexable for enhanced reproducibility from imaging through treatment. It easily attaches to the Evolve breastboard.

MTWB09	
--------	--



## Tapered Wing Board

The Tapered Wing Board is 22" (56 cm) wide and has angled wings, providing patient comfort and support. Its narrow profile is ideal for CT and PET bores. It is MR Safe and available with a T- or U-Grip Handle.

MTWB10T	w/ T-Grip
MTWB10U	w/ U-Grip (shown)



## Grip Options

Both the T-Grip and the U-Grip are available individually. Compatible with the Extended and Tapered Wing Boards.

MTGBSUB1	T-Grip
MTGBSUB3	U-Grip



See page 123 for the Monarch Overhead Arm Positioner

See page 126 for the ArmShuttle Elite

See page 130 for the Pro Wing Board

See pages 109-114 for compatible headrest options

# Thorawedge™

The Thorawedge is a unique positioning device allowing the patient to incline at multiple fixed angles, creating a comfortable position during diagnostic procedures.

The Thorawedge was co-developed with the Department of Radiotherapy of the University Medical Center in Utrecht, The Netherlands.

- Consists of two wedges (5° and 10°) and a comfortable arm support
- Wedges can be used separately or combined to reach a 15° angle. Additional 5° wedges can be added to form 20° and 25° angles
- Headrest and lumbar support can be indexed, assuring a reproducible patient position throughout the course of treatment
- Large side cut-outs allow for a full range of treatment angles
- Thorawedge locator allows quick indexing of the device to the couchtop in combination with a Lok-Bar

301080	Thorawedge
301081	Additional 5° Wedge
301082	Additional 10° Wedge
TW1100	Thorawedge Locator

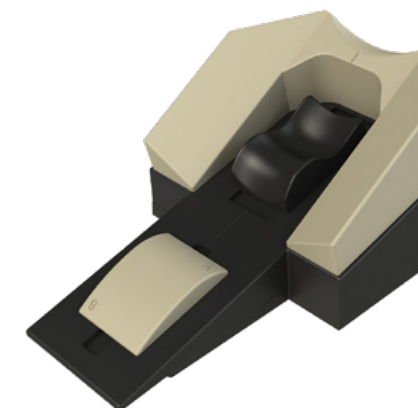

Thorawedge Locator

# Hip, Pelvis, & Extremities



140-141  
THERMIFIX & HIPFIX  
IMMOBILIZATION SYSTEMS

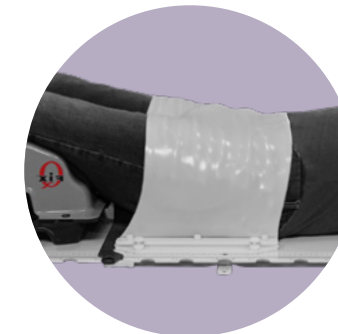

142  
ALTA PELVIS  
THERMOPLASTIC



144  
KNEE & FOOT  
SUPPORTS



145  
BELLYBOARDS

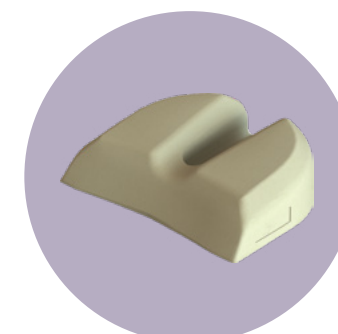

147  
POSITIONING CUSHIONS

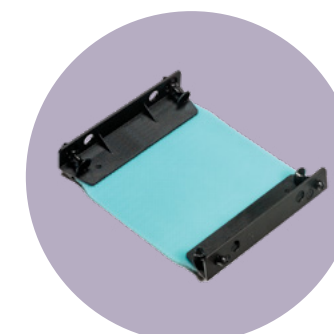

149  
MULTIFIX



150  
ENDORECTAL BALLOON



# ThermFix™ Immobilization System

The ThermFix Immobilization System uses a single sheet of thermoplastic that forms over the breast, thorax, abdomen, hip, or pelvis to aid patient positioning and reproducibility. The ThermFix Bars easily attach and index to the TotalRT All in One Platform or Universal Couchtop and provide 1 cm indexing.

- Bar design provides a larger and more homogenous treatment area compared to a baseplate
- Multiple length and width indexing options accommodate many patient sizes
- Allows supine or prone positioning
- The inferior bar can be removed during patient load/unload to provide safer transitions
- Vac-Lok, RediFoam Cushions, and Wing Boards can be integrated for added comfort and support
- MR Safe, CT, and treatment compatible

## ThermFix Base Package

Includes: Superior Bar, Inferior Bar, Spacing Tool (for breast, thorax, abdomen, hip and pelvic treatment with no central docking)

THRMTX100



## ThermFix Pelvic Package

Includes: Superior Bar, Hip & Pelvic Bar, Spacing Tool (for hip and pelvic treatment with central docking)

THRMTX101

## ThermFix Complete Package

Includes: Superior Bar, Inferior Bar, Hip & Pelvic Bar, Spacing Tool

THRMTX102

# HipFix® Immobilization System

The HipFix hip and pelvis immobilization system utilizes a single sheet of thermoplastic over the entire abdomen and pelvis region, providing immobilization for fixed fiducial targeting. The versatile system accommodates both prone and supine patient setups.

- Indexable baseplate features a cutout treatment window
- Vac-Lok or RediFoam Cushion can be integrated for added comfort, support, and repositioning accuracy
- MR Safe, CT, and treatment compatible

MTPLVC04MR HipFix Baseplate

MTVL71FC Split-Leg Vac-Lok (see page 155)

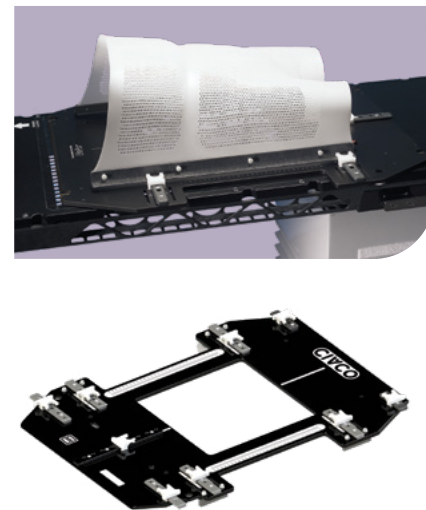

# ThermFix & HipFix Thermoplastics

Thermoplastics are 18" x 22" (45.7 cm x 55.8 cm) and available with reloadable or disposable handles with solid, standard perforated or IMRT Reinforced perforation styles. The handles and groin piece secure to the device, providing an indexable setup.

MTPLHA01 Reloadable Handles (x2) & Groin Piece

MTPLVCSUB8 Reusable Groin Piece for Hip Fix Thermoplastic

PERFORATION	HANDLE TYPE	THICKNESS	PART #	QTY	MATERIAL TYPE
Solid	Reloadable	3.2 mm	MTHFX1822S	5	Aquaplast RT
Solid	Reloadable	2.4 mm	MTHFX18222.4S	5	Aquaplast RT
Solid	Disposable*	3.2 mm	MTPLHA0201	5	Aquaplast RT
Perforated	Reloadable	3.2 mm	MTHFX1822	5	Aquaplast RT
Perforated	Reloadable	2.4 mm	MTHFX18222.4	5	Aquaplast RT
Perforated	Disposable*	3.2 mm	MTPLHA0202	5	Aquaplast RT
IMRT Reinforced	Reloadable	3.2 mm	MTHFI1822	5	Aquaplast RT
IMRT Reinforced	Reloadable	2.4 mm	MTHFI18222.4	5	Aquaplast RT
IMRT Reinforced	Disposable*	3.2 mm	MTPLHAI0203	5	Aquaplast RT
Perforated	Disposable*	3.2 mm	RT-1882KP	5	Fibreplast
Solid	Disposable*	3.2 mm	RT-1821KP	10	Fibreplast
Perforated	Disposable*	3.2 mm	RT-1882P	5	Aquaplast RT
Solid	Disposable*	3.2 mm	RT-1821P	10	Aquaplast RT

\*Groin piece sold separately  
All disposable thermoplastics are MRI compatible

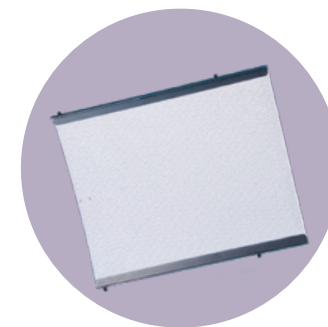

Standard Perforated Thermoplastic



IMRT Reinforced Thermoplastic

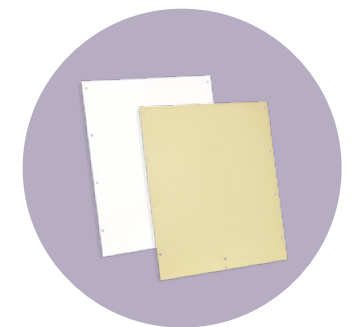

Disposable Precuts

## Alta Multipurpose Device for Pelvis

Alta allows positioning and immobilization of patients for pelvic applications through the use of pelvis thermoplastics and other pelvic positioning products. FlexLock accessories can be used to increase patient comfort and make fine positioning adjustments.

RT-4800-01	Alta Multipurpose Device
RT-4800-GL	Alta Groin Lock
RT-4800-H30	Alta Opti-Handles, 300 mm, set of 2
RT-4800-H45	Alta Opti-Handles, 450 mm, set of 2



Alta Groin Lock



Alta Opti-Handles, 450 mm

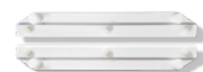

Alta Opti-Handles, 300 mm

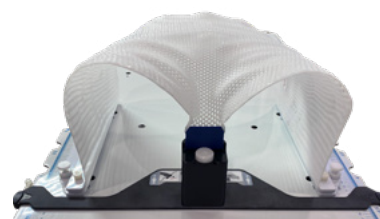

Alta Groin Lock shown with Pelvis Thermoplastic and Alta Opti-Handles

## Aquaplast RT Aqua-Brief

The pelvis thermoplastic series is compatible with the Carbon Fiber Pelvis System and the Alta Multipurpose device. These thermoplastics allow for the immobilization of the pelvis region. The system flattens the lower lumbar for added comfort and repeatability. Aquaplast RT is available in 2.4 mm and 3.2 mm thickness. See page for 143 thermoplastic options.

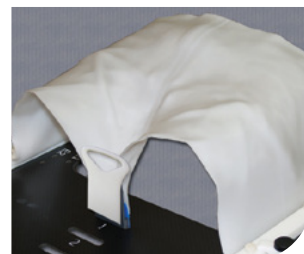

The Aqua-Brief technique uses a sheet of Aquaplast RT and a three-point fixation system covering the pelvis region and not the abdomen. The Groin Lock Key provides a secure, indexable patient fixation.

## Pelvis

FOR USE WITH ALTA MULTIPURPOSE DEVICE & CARBON FIBER PELVIS SYSTEM

### Compatible with 300 mm Opti-Handles

RT-1848	Aquaplast RT, 300 mm x 600 mm x 3.2 mm (12 in x 24 in), Solid with bonded Groin Lock (pre-punched for 300 mm handles)
RT-1883P12A	Aquaplast RT, 300 mm x 450 mm x 3.2 mm (12 in x 18 in), Standard Perf with bonded Groin Lock (pre-punched for 300 mm handles)
RT-1823P12A	Aquaplast RT, 300 mm x 450 mm x 3.2 mm (12 in x 18 in), Solid with bonded Groin Lock (pre-punched for 300 mm handles)

### Compatible with 450 mm Opti-Handles

RT-1882P18A	Aquaplast RT, 450 mm x 600 mm x 3.2 mm (18 in x 24 in), Standard Perf with bonded Groin Lock (pre-punched for 450 mm handles)
RT-1822P18A	Aquaplast RT, 450 mm x 600 mm x 3.2 mm (18 in x 24 in), Solid with bonded Groin Lock (pre-punched for 450 mm handles)

### 450 mm Opti-Handles without Groin Lock

RT-1783P3	Aquaplast RT, 300 mm x 450 mm x 2.4 mm (12 in. x 18 in.) Standard Perf
-----------	--

FOR USE WITH OTHER SYSTEMS

### Pelvis Precut for ORF 4-Point System

RT-1882ORFPLV4	Aquaplast RT Pelvis Precut with pre-bonded disposable handles for ORF 4-point system, 3.2 mm, Standard Perf
----------------	---

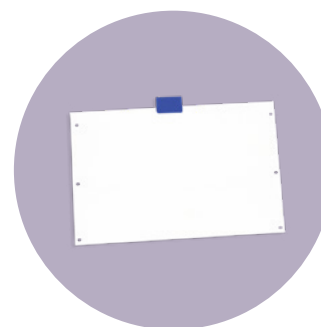

Opti-Handles

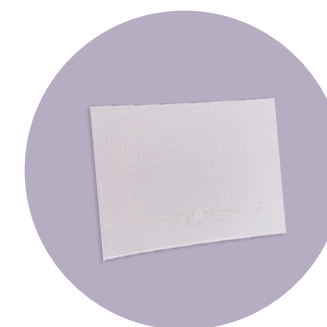

Opti-Handles without Groin Lock

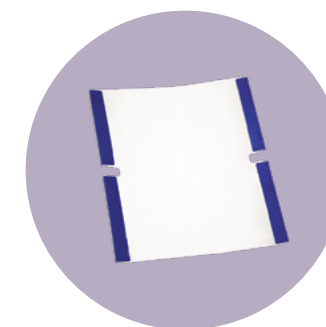

Pelvis Precut for ORF 4-Point System



# FlexLock™ Knee & Foot Supports

## REPRODUCIBLE POSITIONING & PATIENT COMFORT

Provide customizable indexing options for positioning the lower abdomen, pelvis, and lower extremities.

The novel FlexLock Knee Support allows fine superior to inferior adjustments while the patient is in position. It features integrated height adjustability and is easy to clean. The FlexLock Foot Support can be angled to accommodate patient comfort.

- Ergonomically designed for patient comfort while maintaining reproducible positioning
- Optional clip-on leg and foot straps for added immobilization
- Highly durable and cleanable



RT-4800-FS	FlexLock Foot Support
RT-4800-KS	FlexLock Knee Support
RT-4489STRAP	Leg & Foot Strap Assembly, Set of 2

### Shoulder Retractor Strap

Designed to pull the shoulders down during simulation and treatment. For use with FlexLock & SofTouch Knee & Foot Supports.

RT-4800-SR	Shoulder Retractor Strap
------------	--------------------------

CONTACT SALES FOR CARBON FIBER PELVIS SYSTEM ORDERING INFORMATION

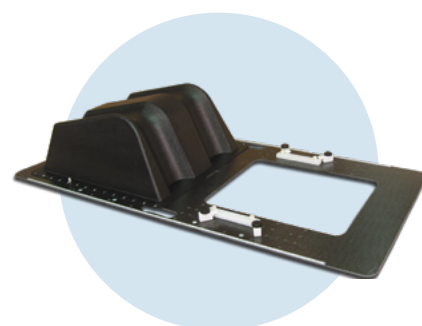

# Combifix™ 3 and Feetfix Couch Support

The Combifix 3 combines the Kneefix and Feetfix, providing enhanced positioning for the pelvic region and other lower extremities.

The Feetfix Couch Support may be used separately and positions the Feetfix at indexed positions, allowing the Feetfix to be tilted at four different angles. Both the Combifix & Feetfix are two- and three-pin Lok-Bar indexable.

Shoulder retractors are available to pull the shoulders down during radiotherapy simulation and treatment sessions where opposed lateral fields are used in the neck area. They can attach in five positions on the Feetfix.

151004MR	Includes Combifix Baseplate, Kneefix 3, Elevation Blocks (x2), Feetfix 3 & Feetfix Couch Support
151005MR	Includes Combifix Baseplate, Low Kneefix 2 Cushion, Elevation Blocks (x2), Feetfix 3 & Feetfix Couch Support
302071MR	Feetfix Couch Support Bracket (Cushion not included)
302072	Shoulder Retractors: Short (x2) and Long (x2)



# Carbon Fiber & MRSeries Bellyboards

The Carbon Fiber Bellyboard assists in reducing the volume of the small bowel that is irradiated in patients undergoing treatment in the pelvic region. The contoured opening allows for displacement of the small bowel, as the central support structure assists in compressing the small bowel forward into the opening.

- Carbon Fiber model features embedded fiducial crosshair to assist as a secondary setup reference
- Lightweight, rigid and indexable
- Lower part of board is adapted to support the patient's upper legs for maximum comfort
- Soft polyethylene padding ensures a comfortable position for the head
- Optional Prone Thorax Support cushion (see page 147)

125012	Carbon Fiber Bellyboard
126000	MRSeries Bellyboard
013140	Bellyboard Wall Storage (see page 213)



Caudal Indentation [1] to relieve pressure in the genital area. Central Space [2] allows compression to push the small bowel superior toward the Major Aperture [3].

# SofTouch™ Elite Bellyboard

Adjustable stabilization platform designed to position the lower bowel away from the treatment field during prostate radiotherapy. The removable caudal cushion and separate belly support cushions allow for custom patient setup. The SofTouch Elite Bellyboard's unique semi-firm radiolucent foam provides repeatable positioning and is contoured to relieve pressure point stress and improve patient comfort. Multiple cushion configurations provide optimal anatomical placement of both external and internal anatomy for improved clinical outcomes.

- Three contoured and adjustable headrests allow for improved patient comfort
- Provides multiple indexing locations to ensure precise, repeatable positioning
- Ergonomic hand grip relieves stress on patient's wrists
- Removable cushions allow for custom patient setup
- Contoured to relieve pressure point stress
- Scales to aid in laser alignment
- Includes wall hook for convenient storage solution
- Lightweight, easy to clean and MRSafe

RT-4464-02 SofTouch Elite Bellyboard



Wall Hook (fasteners not included)

15 mm headrest



The Bellyboard system comes with a prone headrest that can be indexed in multiple locations.

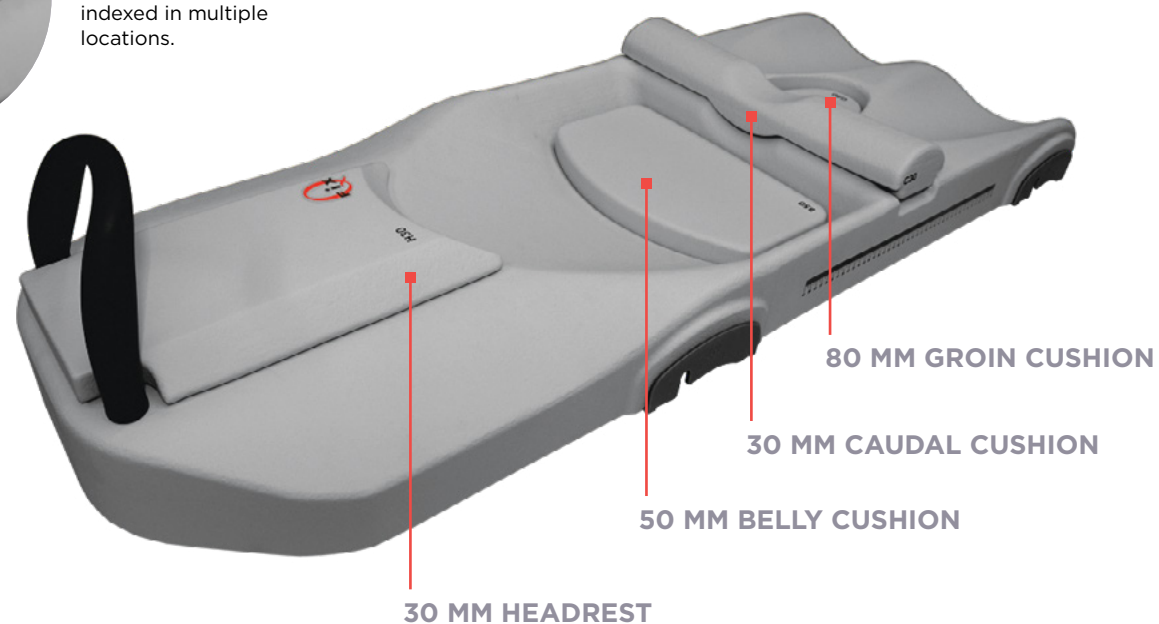

# Positioning Cushions

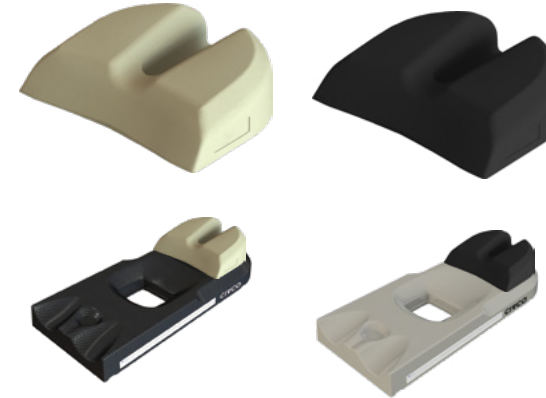

## Prone Thorax Support

The Prone Thorax Support is designed to relieve chest compression during treatments in the prone position. It can be used as a stand-alone patient support or as an option on the Bellyboard to allow large patients to be treated in the prone position.

301076 Cream

301102 Black



## Prone-Lok™ Cushion

The Prone-Lok Positioning Cushion enhances patient comfort through its specially designed foam construction. Its contoured corners eliminate shoulder impingement. The center portal opens the patient's field of view, improving patient comfort. The cushion is indexable and can be easily cleaned and reused.

MTPLC01

## Pron-Pillo™ Cushion

The Pron-Pillo provides comfort and stability for patients in the prone position. The cushion can be easily cleaned and reused.

MTCB36

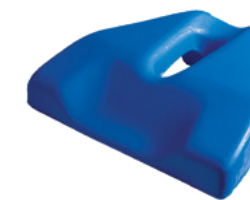



## Positioning Cushions



Kneefix Indexing Holes

### Kneefix™ 3

The Kneefix 3 cushion contributes to better stability and reproducibility in the supine position, regardless of the target area. It promotes patient comfort and is therefore ideal for use during lengthy procedures on rigid surfaces. The Kneefix 3 is 16 cm tall and is made of lightweight, closed cell foam that is easy to clean and is both two- and three-pin indexable. A Low Kneefix 2 (12 cm) is available for additional setup.

301052	Kneefix 3 (Cream)
301048	Low Kneefix 2 (Black)

### Kneefix 3 Elevation Blocks

The Kneefix 3 Elevation Blocks can elevate the Kneefix 3 by 5 cm. The Kneefix fits in the topside of the elevation block and will not slide off. Elevation Blocks may be stacked to raise the legs even higher. The Kneefix 3 Elevation Blocks are both two- and three-pin indexable.

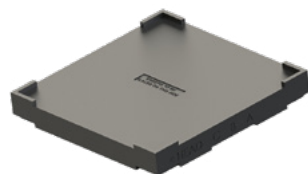

301055	Qty 1
301056	Qty 3

### Feetfix™ 3

The Feetfix 3 is a universal patient support cushion for radiotherapy and diagnostic procedures and has been designed to provide comfortable positioning with enhanced immobilization. The Feetfix 3 is 16 cm tall and is made of lightweight, closed cell foam that is easy to clean. It can be used with either a two- or three-pin indexable Lok-Bar or with the Feetfix Couch Support (page 145).



301071	Feetfix 3 (Cream)
--------	-------------------

## Positioning Cushions

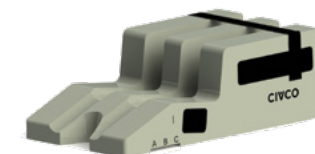
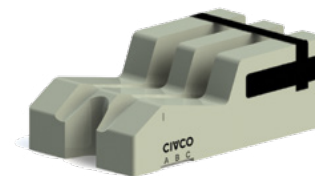

### Dual Leg Positioner

The Dual Leg Positioner provides a quick capture of the lower legs for supine hip and pelvic treatments. The positioner is designed to hold the legs at the same level, thereby reducing rotation of the pelvis. An optional Velcro® strap secures the calves and ankles. It is indexable for enhanced reproducibility. It can be easily cleaned and reused.

MTDLI2	Standard (76 x 46 x 19 cm) (top photo)
MTDLI2Z	Low (76 x 46 x 11 cm) (bottom photo)

## MultiFix™

The Multifix is a flexible system allowing arms and legs to be fixed in straight or bent positions, using small Posicast precuts. These precuts are easily shaped to anatomical contours and are then fixed onto the baseplate on clearly indicated positions.

Indexable baseplate ensures a reproducible setup

Four sets of indexing holes offer an isocentric position of the treated extremity wherever it is placed on the Multifix

107063	Multifix Baseplate, Carbon Fiber
930080	Small Multifix Posicast-Plus Microperfo Thermoplastic



# RectalPro™ 75 Endorectal Balloon (ERB)

The curved shaft design promotes patient comfort. Air/water fill volume is variable to meet clinical needs and allows for reproducible balloon positioning. Overall, limits prostate movement while the beam is on and allows reproducible positioning.

- Reduces ano-rectal toxicity
- Increases gland stability
- Improved daily reproducibility
- Promotes rectal wall and sphincter sparing
- Reduces intra-fraction prostate motion

**RT-4415RP-50** RectalPro 75 Endorectal Balloon  
(Quantity 50 with 100 ml Syringe)

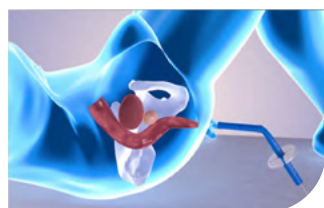

Insert the ERB tip towards the table/couch and follow the anatomical curve of the colon

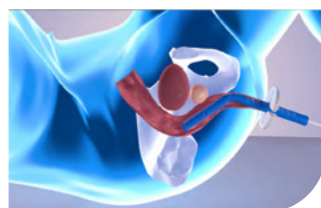

ERB inserted

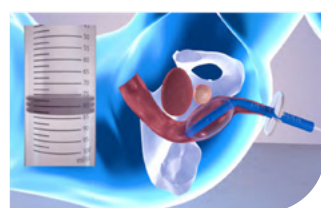

Slowly inflate with air/water 60-100 ml with physician's directions

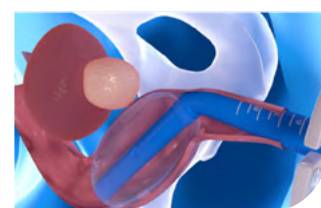

After inflation, pull down the ERB and affix the stopper

## Vacuum & Positioning Cushions





# Vac-Lok™ Cushions

Vac-Lok Cushions create a rigid and secure support around the patient when a vacuum is drawn through a self-sealing quick-release valve. These cushions retain their shape and guarantee stability and reproducibility of the patient's position for up to six weeks once the air is vacuumed out.

- More rigid than previous generation (cream) bags
- Protective material coating provides greater cleanability than previous generation bags
- Attached indexing battens (on specific sizes) provide an easy method for repositioning
- Available for a span of clinical setups including head & neck, breast, pelvic & hip, and full body
- Treatment area is artifact-free with minimal beam attenuation
- Reusable for ultimate cost-effectiveness
- Available in gray nylon or clear urethane
- Cleared for use in proton therapy



Indexing battens provide an easy method for repositioning Vac-Lok Cushions



Self-sealing quick-release valve

## Rectangular Vac-Lok Cushions

DIMENSIONS	FILL	URETHANE	NYLON	NYLON W/ INDEXING
25 x 50 cm	2.25 L	VLE225	VLE225C	-
50 x 70 cm	15 L	VL15	VL15C	VL15FC
70 x 70 cm	20 L	VLJ20	VLJ20C	VLJ20FC
70 x 100 cm	26 L	-	VLG26C	VLG26FC
70 x 100 cm	35 L	VLG35	VLG35C	VLG35FC
70 x 100 cm	40 L	VLG40	VLG40C	VLG40FC
75 x 100 cm	21 L	-	VLPLV09C	VLPLV09FC
75 x 100 cm	28 L	VLPLV01	VLPLV01C	VLPLV01FC
75 x 120 cm	34 L	VLPLV02	VLPLV02C	VLPLV02FC
75 x 120 cm	25 L	-	VLPLV10C	VLPLV10FC
75 x 150 cm	50 L	VLFB01	VLFB01C	VLFB01FC
75 x 180 cm	62 L	-	-	VLFB02FC
100 x 100 cm	40 L	VLB40	VLB40C	-
100 x 150 cm	80 L	-	VLA80C*	-
100 x 200 cm	90 L	-	VLH90C*	-

\*Some Vac-Lok Cushions require longer lead time. Please ask your sales representative for lead times.

# Non-Rectangular Vac-Lok Cushions

CUSHION	DIMENSIONS	FILL	URETHANE	NYLON	NYLON W/ INDEXING	PHOTO PAGE
Head & Shoulders "T"	50 x 70 cm	6 L	VL37	-	-	155
"T"	87.5 x 140 cm	25 L	-	VL14C25*	-	-
"T" Tapered Mid-section	108 x 125 cm	44 L	-	-	VL0017	154
"T" Non-Tapered Mid-section	108 x 125 cm	42 L	-	-	VL0018	154
"T" Tapered Mid-section w/ Handle Cutout	108 x 125 cm	31 L	-	-	VL0022	-
Type-S	61 x 65 cm	8 L	-	-	VLTY01CX	155
Type-S	140 x 65 cm	27 L	-	-	VLTY02CX	155
Arms Up	75 x 75 cm	20 L	VLARM01	VLARM01C	VLARM01FC*	154
Arms Up	105 x 75 cm	28 L	-	VLARM02C	VLARM02FC	154
One Arm Up	100 x 80 cm	34 L	-	VL04C	-	154
Wing Board	88 x 55 cm	15 L	VLWGB03	VLWGB03C	-	154
Monarch Wing Board	108 x 55 cm	17 L	-	VLWGB04C	-	154
Monarch Wing Board w/ Head Support Cutout	108 x 55 cm	14 L	-	VLWGB05C	-	154
Split Leg	60 x 100 cm	15 L	-	-	VL71FC	155

\*Some Vac-Lok Cushions require longer lead time. Please ask your sales representative for lead times.



75 x 120 cm (Rectangular Cushion)



105 x 75 cm (Arms Up Cushion)



108 x 55 cm (Monarch Wing Board Vac-Lok)



108 x 125 cm (T-Shape Cushion w/ Tapered mid-section)

## Breast & Thorax Vac-Lok Cushions

Vac-Lok cushions create a rigid and secure support around the patient when a vacuum is drawn through a self-sealing quick-release valve. Cushions are available in two durable finishes: nylon and urethane. Nylon cushions can be ordered with indexing bars attached. Cleared for use in proton therapy.



### Arms Up Vac-Lok, 105 cm long, 28 L Fill

VLARM02C	Nylon
VLARM02FC	Nylon w/ indexing



### Arms Up Vac-Lok, 75 cm long, 20 L Fill

VLARM01	Urethane
VLARM01C	Nylon
VLARM01FC*	Nylon w/ indexing



### Wing Board Vac-Lok, 88 x 55 cm, 15 L Fill

VLWGB03	Urethane
VLWGB03C	Nylon



### Monarch Wing Board Vac-Lok, 108 x 55 cm

VLWGB04C	Nylon, 17 L Fill
VLWGB05C	Nylon w/ Head Support Cutout, 14 L Fill



### T-Shape Vac-Lok, 108 x 125 cm

VL0017	Nylon w/ indexing, Tapered mid-section, 44 L Fill
VL0018	Nylon w/ indexing, Non-tapered mid-section, 42 L Fill
VL0022	Nylon w/ indexing, Tapered mid-section and Handle Cut Out, 31 L Fill



### One Arm Up Vac-Lok, 34 L Fill

VL04C	Nylon
-------	-------

\*Some Vac-Lok Cushions require longer lead time. Please ask your sales representative for lead times.

## Head & Neck Vac-Lok Cushions



### "T" Cushion

VL37	50 x 70 cm "T" Vac-Lok Cushion
------	--------------------------------

### Type-S Cushion

VLTY01CX	Type-S Vac-Lok Cushion (short)
VLTY02CX	Type-S Vac-Lok Cushion (long)

## Hip & Pelvic Vac-Lok Cushions



### 75 x 100 cm

VLPLV09C	Nylon, 21 L Fill
VLPLV09FC	Nylon w/ indexing, 21 L Fill
VLPLV01	Urethane, 28 L Fill
VLPLV01C	Nylon, 28 L Fill
VLPLV01FC	Nylon w/ indexing, 28 L Fill

### 75 x 120 cm

VLPLV10C	Nylon, 25 L Fill
VLPLV10FC	Nylon w/ indexing, 25 L Fill
VLPLV02	Urethane, 34 L Fill
VLPLV02C	Nylon, 34 L Fill
VLPLV02FC	Nylon w/ indexing, 34 L Fill

### Split Leg Cushion

For use with the HipFix System (see page 140).

VL71FC	Nylon w/ indexing, 15 L Fill
--------	------------------------------

See pages 152 & 153 for more information on Vac-Lok cushions.



# VacQfix™ Cushions

Custom formed for patient comfort and positioning accuracy, becoming rigid when vacuum is applied. They can be cleaned and reused after each course of treatment. Our fine denier fabric and small-diameter foam bead fill combine to increase conformity and reproducibility.



## SingleStep™ Valve

Unlike other systems, the unique SingleStep Valve does not require a secondary cap to ensure leak-free operation. It is standard on all VacQfix cushions.



## Economy 2-Piece Valve\*

All VacQfix Cushions are available with the economy 2-piece valve upon request.



NYLON	DIMENSIONS	FILL	CUSHION	PHOTO PG
RT-4517-4080F15	40 x 80 cm	15 L	Extremities	157
RT-4517-4079VF15	40 x 80 cm	15 L	SBRT, thigh compression	-
RT-4517-5070F15	50 x 70 cm	15 L	Extremities	157
RT-4517-7070F20	70 x 70 cm	20 L	Upper body	157
RT-4517-T6565F7	65 x 65 cm	7 L	Head & Shoulders (T-Shape)	157
RT-4517-T7993F20	79 x 93 cm	20 L	Breastboard	157
RT-4517-10070F30	70 x 100 cm	30 L	Multi-purpose use	-
RT-4517-10070F35	70 x 100 cm	35 L	Multi-purpose use	157
RT-4517-10070F40	70 x 100 cm	40 L	Multi-purpose use	-
RT-4517-100100F30	100 x 100 cm	30 L	Multi-purpose use	-
RT-4517-100100TRAPF35	100 x 100 cm	35 L	Trapezoid	158
RT-4517-100100F40	100 x 100 cm	40 L	Upper body	-
RT-4517-80150F65	80 x 150 cm	65 L	Hip or pelvis	158
RT-4517-70120F40	70 x 120 cm	40 L	Multi-purpose use	159
RT-4517-12075F35	75 x 120 cm	35 L	Multi-purpose use	158
RT-4517-PB3	55 x 96 cm	12 L	Access prone with headrest cutout	158
RT-4517-PB4	55 x 96 cm	15 L	Access prone without headrest cutout	158
RT-4517-100220F120	100 x 220 cm	120 L	Full body	159
RT-4517-230120T80F90	120 tapered to 80 x 230 cm	90 L	SBRT, whole body	159
RT-4517-0002	120 tapered to 80 x 160 cm	90 L	2-Chamber	159
RT-4517-0003	120 tapered to 80 x 230 cm	90 L	3-Chamber	159

\*For Economy Valve, add "M" to the end of the product code when ordering.

Dimensions listed are approximate measurements for cushions with no fill. Dimensions are for reference only.

# VacQfix Cushions

All VacQfix Cushions come with SingleStep Valve Standard. To order the Economy Valve, add "M" to the end of the corresponding product code.

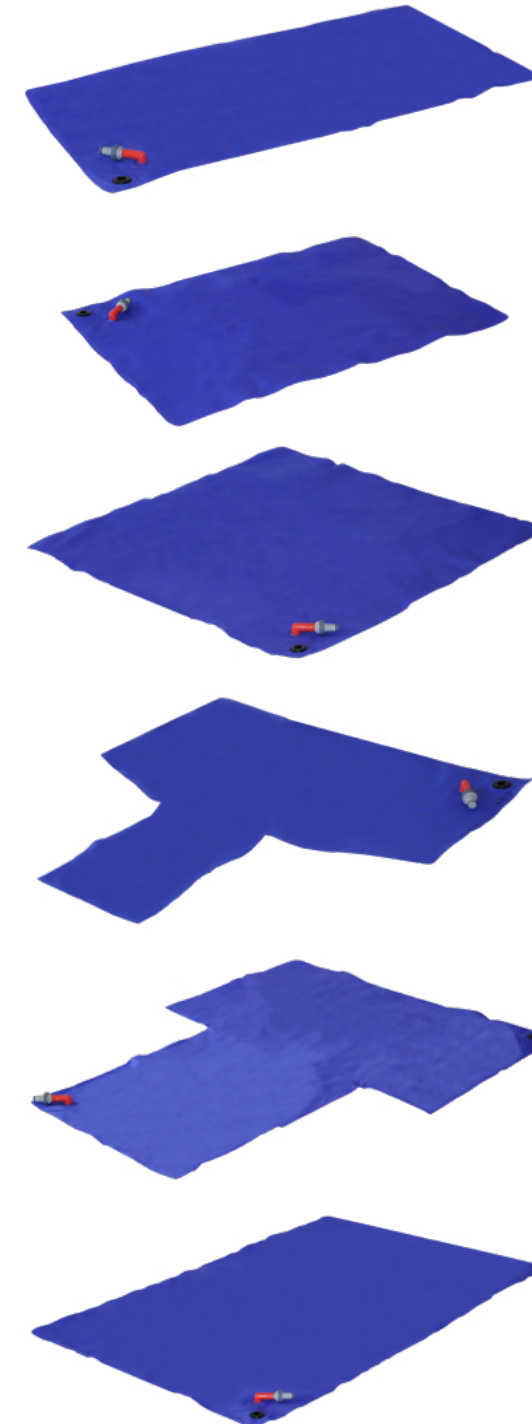

**RT-4517-4080F15** 40 x 80 cm, 15 L Fill, for extremities

\*RT-4517-4079VF15 - VacQfix Cushion, Thigh Compression SBRT, 400 mm x 800 mm, Nylon, 15 L Fill is also available with the same dimensions as RT-4517-4080F15

**RT-4517-5070F15** 50 x 70 cm, 15 L Fill, for extremities

**RT-4517-7070F20** 70 x 70 cm, 20 L Fill, for upper body

**RT-4517-T6565F7** 65 x 65 cm, T-Shaped, 7 L Fill, for head & shoulders

**RT-4517-T7993F20** Breastboard Cushion, 79 x 93 cm, 20 L Fill

**RT-4517-10070F35** 70 x 100 cm, 35 L Fill

Dimensions listed are approximate measurements for cushions with no fill. Dimensions are for reference only.

# VacQfix Cushions



**RT-4517-100100F40** 100 x 100 cm, 40 L Fill, for upper body

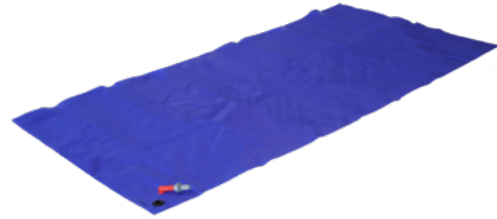

**RT-4517-80150F65** 80 x 150 cm, 65 L Fill, for hip or pelvis

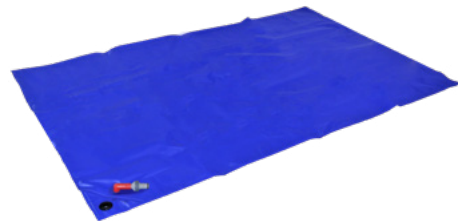

**RT-4517-12075F35** 75 x 120 cm, 35 L Fill



**RT-4517-100100TRAPF35** 100 x 100 cm, Trapezoid, 35 L Fill



**RT-4517-PB3** Access Prone VacQfix Cushion with headrest cutout, 55 x 96 cm

**RT-4544KV-IND** Prone VacQfix Indexer



**RT-4517-PB4** Access Prone VacQfix Cushion without headrest cutout, 55 x 96 cm

**RT-4544KV-IND** Prone VacQfix Indexer

Dimensions listed are approximate measurements for cushions with no fill. Dimensions are for reference only.

# VacQfix Cushions



**RT-4517-0002** 120 x 160 cm/80 cm, 2-Chamber



**RT-4517-0003** 120 x 230/80 cm, 3-Chamber



**RT-4517-230120T80F90** 120 tapered to 80 x 230 cm, Whole Body SBRT, 90 L Fill



**RT-4517-70120F40** 70 x 120 cm, 40 L Fill



**RT-4517-100220F120** 100 x 220 cm, 120 L Fill, full body

Dimensions listed are approximate measurements for cushions with no fill. Dimensions are for reference only.



## Vac-Lok & VacQfix Accessories



### Vac-Lok Cleaner

This spray is available for use on Vac-Lok cushions.  
**ONLY AVAILABLE IN THE U.S.**

MTCBPFC



### Helping Hands™

The Helping Hands Cushion Manager is designed to help handle large-size Vac-Lok cushions that tend to hang off the couch during the forming process.

MTVLHH150      150 cm long



### I.D. Tags

Color-coded tags provide quick identification of patient cushions. Tags are available in assorted colors and include tie strings.

MTVLTAG      Pack of 25 Tags, Assorted Colors



### Storage Racks

This space-saving rack holds molded & inflated cushions. Plastic "S" hooks are available for hanging cushions.

MTVL401      Storage Rack, Double Wide

MTVL402      Casters for MTVL401, Qty 4

MTVLHOOK      "S" Hooks, Qty 10

## Vac-Lok & VacQfix Accessories



### Slide Guide Lok-Bar

The Slide Guide Lok-Bar does not lock down to the indexing points along the couchtop but slides longitudinally along the couchtop. It is designed to prevent lateral movement and is useful for longer devices such as bellyboards, breastboards and Vac-Lok Cushions, which contract during forming.

MTVL00853

MTIL1006      Transverse

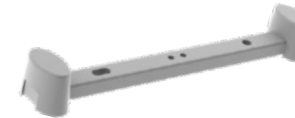

### VacQfix Indexer

RT-4517-IND01



### Prone VacQfix Indexer

RT-4544KV-IND

# Vacuum Compressors

## Dual Function Compressors

The Dual Function Vacuum Compressor, available in a 115V and 230V version, provides both a vacuum and inflate cycle with a convenient hand control or foot control. It provides an audible alarm when your optimum vacuum level is reached.



MTVP1	115V
MTVPEXA	230V, Europe
MTVPEXC	230V, Australia
MTVPEXD	230V, UK
MTVPEXG	230V, India
MTVPEXH	230V, Israel
MTVPFT	Foot Control (optional) (right photo)

## Vacuum Pumps

Simple to use and allows you to mold firm, stable patient positioning cushions in minutes. The Hose Adapter Kit allows you to use your current pump with our VacQfix cushions.



VacQfix Standard Dual Mode Vacuum Pump, 220-volt

RT-PUMPQ1	VacQfix Standard Dual Mode Vacuum Pump, 110-volt, includes hose
RT-PUMP220Q1	VacQfix Standard Dual Mode Vacuum Pump, 220-volt, includes hose (left photo)
RT-4517-HOSE	VacQfix Adapter Hose (allows industry standard pumps to accept our SingleStep Valve)
RT-PUMPQ-TS	Toggle Switch for Standard Dual Mode Pump
RT-PUMP-KIT	Hose Adapter Kit



Toggle Switch for Standard Dual Mode Pump



Hose Adapter Kit

# Positioning Cushions

## RediFoam™ Two-Part Positioning Foam

RediFoam two-part positioning foam is both CFC- and TDI-free. You can make setup marks directly onto RediFoam for verifiable repositioning throughout treatment.



MTFA39B	RediFoam, Small Includes 33 x 40" (83.8 x 101.6 cm) RediFoam bag
MTFA40B	RediFoam, Large Includes 39 x 46" (99.1 x 116.8 cm) RediFoam bag
MTFA41B	RediFoam, X-Large Includes 39 x 56" (99.1 x 142.2 cm) RediFoam bag

ONLY AVAILABLE IN THE U.S.

## Multi-Purpose Support Cushions

Multi-Purpose Support Cushions are exclusive closed cell PE foam that will not stain or absorb liquids. They are more firm than regular, coated support cushions. Five different shapes are sold separately or as a complete set, which also includes a Hand/Finger Positioner.

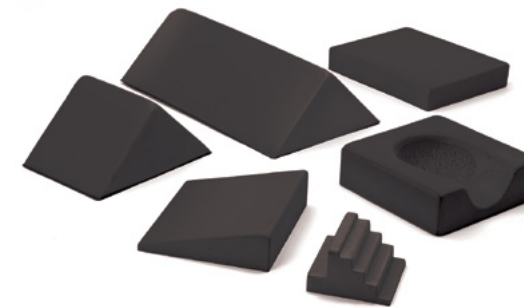

403024	Rectangle	30 x 24 x 5 cm
402422	15° Wedge	24 x 22 x 7 cm
402848	45° Wedge	28 x 48 x 14 cm
402820	45° Wedge	28 x 20 x 14 cm
402525	Head Support	25 x 25 x 8 cm
400006	Set of Six	-

NOTE: HAND/FINGER POSITIONER ONLY AVAILABLE IN SET OF SIX (40006)

## Shoulder Support Cushion

The Shoulder Support Cushion is a wedge shaped cushion designed to support the shoulders and upper body of the patient. When placed over the Posifix-1 or -2 baseplate, the contours of the baseplate hold the cushion firmly in place.

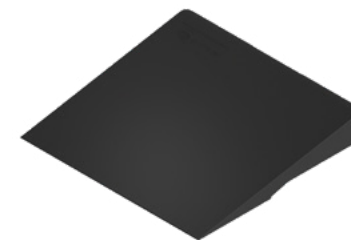

301040	Shoulder Support Cushion
--------	--------------------------

## Leg Roll Positioner

Quality foam cushions are durable for everyday use and will maintain consistent shape and patient comfort. Colors may vary.



RT-4474-6	60 x 15 cm (24 in x 6 in)
RT-4474-8	60 x 20 cm (24 in x 8 in)



## Foam Positioners

These foam positioning aids are encased in blue vinyl fabric. They are designed for optimal durability and comfort and can easily be cleaned and reused.



<b>RT-4487</b>	Standard 6-Piece Set Includes: RT-4487-35/55, RT-4487-45-24, RT-4487-15, RT-4487-20, RT-4487-11, RT-4487-6	
<b>MTVIPFFF101C / RT-4487-35/55</b>	35°/55° Angle Wedge	6.75 x 9.75 x 24" (17.1 x 24.8 x 61 cm)
<b>MTVIPFFF102C / RT-4487-45-24</b>	45° Angle Wedge	7 x 7 x 24" (17.8 x 17.8 x 61 cm)
<b>MTVIPFFF103C / RT-4487-15</b>	15° Angle Wedge	3 x 11 x 7" (7.6 x 27.9 x 17.8 cm)
<b>MTVIPFFF405C</b>	15° Angle Wedge	3 x 11 x 36" (7.6 x 27.9 x 91.4 cm)
<b>MTVIPFFF104C / RT-4487-20</b>	20° Angle Wedge	4 x 11 x 7" (10.2 x 27.9 x 17.8 cm)
<b>MTVIPFFF203C / RT-4487-27</b>	27° Angle Wedge	6 x 10 x 10" (15.2 x 25.4 x 25.4 cm)
<b>MTVIPFFF205C / RT-4487-45-10</b>	45° Angle Wedge	10 x 10 x 10" (25.4 x 25.4 x 25.4 cm)
<b>MTVIPFFF407C / RT-4487-45-30</b>	45° Angle Wedge	7 x 7 x 30" (17.8 x 17.8 x 76.2 cm)
<b>MTVIPFFF301C / RT-4487-4565</b>	45°/65° Angle Wedge	6 x 7.25 x 12.5 x 21" (15.2 x 18.4 x 31.8 x 53.3 cm)
<b>MTVIPFFF302C</b>	Angled Bolster	6 x 7.25 x 12.5 x 15" (15.2 x 18.4 x 31.8 x 38.1 cm)
<b>MTVIPFFF801C / RT-4487-10-1</b>	Rectangle	1 x 7 x 10" (2.5 x 17.8 x 25.4 cm)
<b>MTVIPFFF802C / RT-4487-10-2</b>	Rectangle	2 x 7 x 10" (5.1 x 17.8 x 25.4 cm)
<b>MTVIPFFF105C / RT-4487-11</b>	Rectangle	2 x 7 x 11" (5.1 x 17.8 x 27.9 cm)
<b>MTVIPFFF402C</b>	Rectangle, Chest Positioner	2 x 24 x 14" (5 x 60.9 x 35.6 cm)
<b>MTVIPFFF803C / RT-4487-10-3</b>	Rectangle	3 x 7 x 10" (7.6 x 17.8 x 25.4 cm)
<b>MTVIPFFF804C / RT-4487-10-4</b>	Rectangle	4 x 7 x 10" (10.2 x 17.8 x 25.4 cm)
<b>MTVIPFFF805C</b>	Rectangle	4 x 7 x 20" (10.1 x 17.8 x 50.8 cm)
<b>MTVIPFFF303C</b>	Knee/Back Bolster	5 x 7 x 15" (12.7 x 17.7 x 38.1 cm)
<b>MTVIPFFF106C / RT-4487-6</b>	Circle	6" (15.2 cm)
<b>MTVIPFFF704C</b>	Leg Immobilizer	6 x 14 x 16" (15.2 x 35.5 x 40.6 cm)
<b>MTVIPFFF309C</b>	Bolster	6.5 x 9 x 18" (16.5 x 22.8 x 45.7 cm)
<b>MTVIPFFF401C</b>	Torso Block	7 x 12 x 16" (17.7 x 30.5 x 40.6 cm)
<b>MTVIPFFF502C</b>	Chest/Leg Wedge	15 x 24 x 24" (38.1 x 60.9 x 60.9 cm)

THESE PRODUCTS HAVE NOT BEEN CE MARKED

## Fiducial Markers

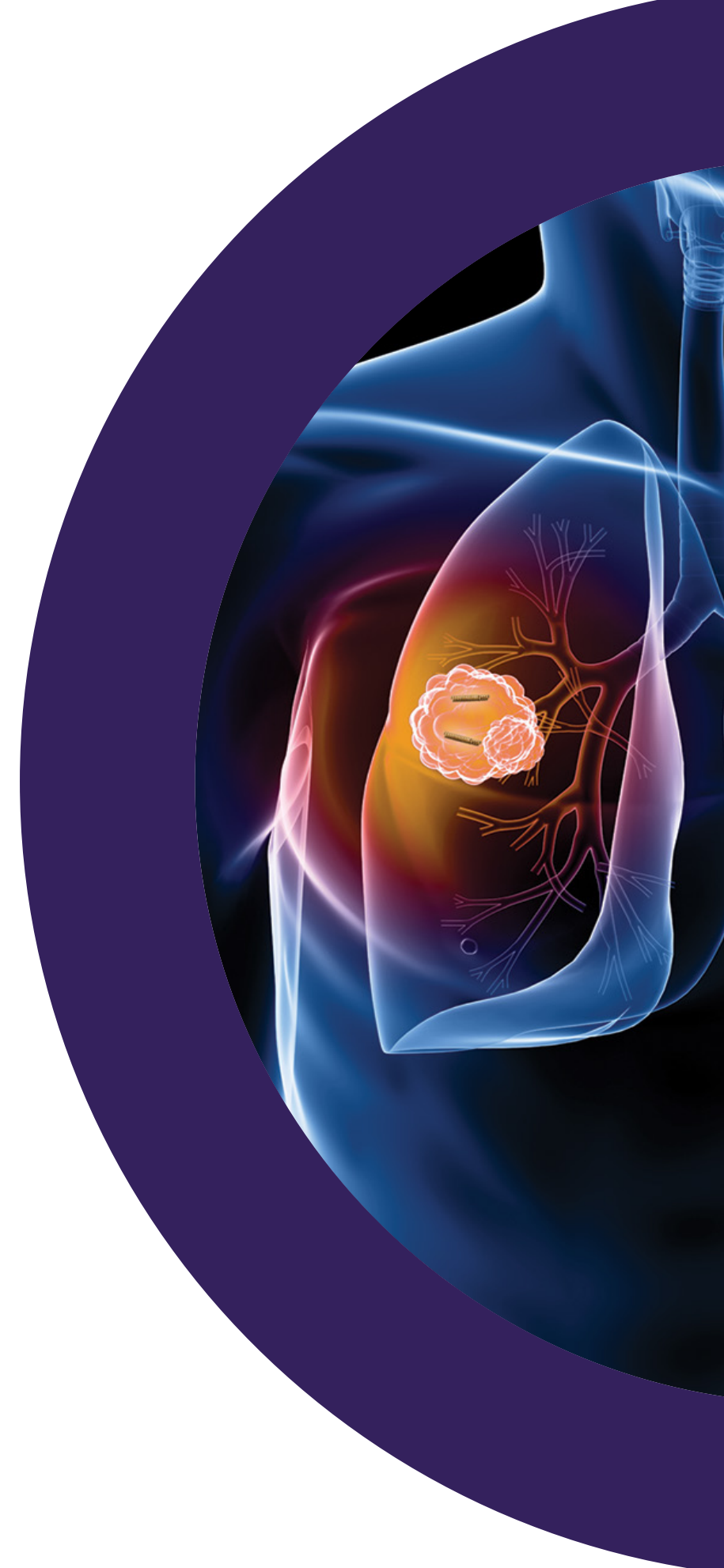

# Fiducial Markers

DISEASE SITE RECOMMENDATIONS

HEAD & NECK
 BREAST
 LUNG
 ABDOMEN
 PROSTATE

## LARGEST SELECTION OF SPECIALLY DESIGNED FIDUCIALS INCLUDES

- Linear gold coils with solid identifiable end points
- Linear gold coils specific for MRI and CT fusion
- Biocompatible artifact free polymer markers
- Fiducials linked at a specific distance for precise localization

## GOLD MARKER FEATURES

- Specially knurled surface is designed to inhibit migration
- 99.9% pure gold
- Non-biological imaging characteristics make markers easier to identify

## MULTIPLE NEEDLE GAUGE SIZES

- 20, 19, 18 and 17 gauge needles

## FusionCoil™

The FusionCoil Marker images equally as well in CT as it does in MRI. It consists of an open spiral gold coil with a special biocompatible alloy core that appears as a solid black dot in MRI. This is the first of its kind, providing superior reference for image fusion as well as precise IGRT.



MTCTXFC1051820	1 x 5 mm marker	18 GA ETW x 20 cm needle	Qty 1	
MTCTXFC10201820	1 x 20 mm marker	18 GA ETW x 20 cm needle	Qty 1	
MTCTXFC10251820	1 x 5 mm marker	18 GA ETW x 20 cm needle	Qty 1	
Includes 2 markers with a 15 mm bioabsorbable spacer. <b>NOT CE MARKED</b>				
MTCTXFC1051825	1 x 5 mm marker	18 GA ETW x 25 cm needle	Qty 1	

## FusionCoil SBRT Kit

Cartridge Kits reduce the number of needle passes and minimize the chance of Edema or Pneumothorax.

MTCTXFC001	Pre-loaded FusionCoil needle, 18 GA x 20 cm, w/ 1 x 5 mm marker, Qty 1 Pre-loaded FusionCoil cartridges, 1 x 5 mm marker, Qty 2	
MTCTXFC105185	Additional Pre-loaded FusionCoil cartridge, 1 x 5 mm marker, Qty 1	



ALL FIDUCIAL MARKERS ON THIS PAGE ARE CE MARKED UNLESS NOTED AS NOT CE MARKED

# Fiducial Markers

DISEASE SITE RECOMMENDATIONS

HEAD & NECK
 BREAST
 LUNG
 ABDOMEN
 PROSTATE

## PolyMark™

The PolyMark Marker is the first biocompatible polymer-based marker. It minimizes artifact, is visible using kV based IGRT solutions, MRI and is optimized for Proton Therapy.

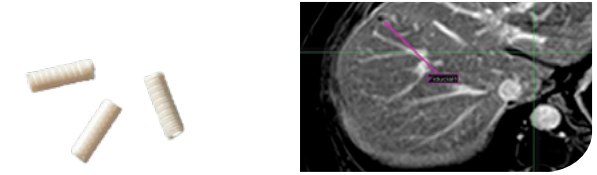

MTCTXPM101820	1 x 3 mm marker	18 GA ETW x 20 cm needle	Qty 1	
MTCTXPM101825	1 x 3 mm marker	18 GA ETW x 25 cm needle	Qty 1	
MTCTXPM0834	0.8 x 3 mm marker Loose, Sterile	-	Qty 4	

## PointCoil™

The PointCoil Marker is a 5mm long helical coil that provides a single unique point for IGRT. The helical design maximizes stability and minimizes artifact.

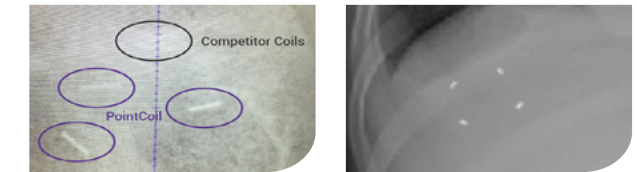

MTCTXPC0605	0.6 x 5 mm marker	20 GA ETW x 20 cm needle	Qty 1	
-------------	-------------------	--------------------------	-------	--

Optimized for Proton. Minimal shadows when administering treatment.

## PointCoil SBRT Kit

Cartridge Kits reduce the number of needle passes and minimize the chance of Edema or Pneumothorax.

MTCTXPC0819153	Trocar placement needle, 19 GA x 15 cm, Qty 1 Pre-loaded PointCoil cartridge, 0.8 x 5 mm marker, Qty 3	
MTCTXPC08185	Additional Pre-loaded PointCoil cartridge, 0.8 x 5 mm marker, Qty 1	



ALL FIDUCIAL MARKERS ON THIS PAGE ARE CE MARKED

# Fiducial Markers





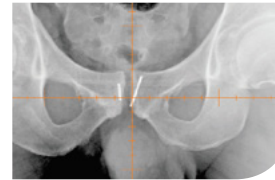

DISEASE SITE RECOMMENDATIONS

 HEAD & NECK
  BREAST
  LUNG
  ABDOMEN
  PROSTATE

## FlexiCoil™

The FlexiCoil Marker is a unique, non-migrating marker with solid end points. FlexiCoil provides a unique image with two nodes that clearly define the end points.





MTCTXFC09101820	0.9 x 10 mm marker	18 GA ETW x 20 cm needle	Qty 1		
MTCTXFC12101720	1.2 x 10 mm marker	17 GA ETW x 20 cm needle	Qty 1		
MTCTXFC12201720	1.2 x 20 mm marker	17 GA ETW x 20 cm needle	Qty 1		

## FlexiMarc™ G/T

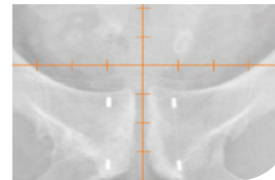
The FlexiMarc G/T Marker provides distinctive non-biological projection with easily definable nodes. The gold nodes are connected with a fine titanium line, which creates the optimal performance characteristics and visualization.















MTCTXGT10182010	1 x 3 mm markers 10 mm spaced	18 GA ETW x 20 cm needle	Qty 1	
MTCTXGT10182020	1 x 3 mm markers 20 mm spaced	18 GA ETW x 20 cm needle	Qty 1	

Optimized for CyberKnife® prostate treatments.

## Coupled Markers

Coupled Markers are 3 mm long with either 0.8 or 1.0 mm diameters attached at a fixed distance, 20 mm apart from center to center. They are secured with a sterile, tissue-absorbable material. This ensures that the markers are implanted at a known distance for calculating precise localization.



MTNW887709	0.8 x 3 mm markers	18 GA ETW x 20 cm needle	Qty 2			
MTNW887710	1 x 3 mm markers	17 GA ETW x 20 cm needle	Qty 1			
MTNW887712	1 x 3 mm markers	17 GA ETW x 20 cm needle	Qty 2			
MTNW887711	1 x 3 mm markers 1.2 x 3 mm markers	17 GA ETW x 20 cm needle 17 GA ETW x 20 cm needle	Qty 1 Qty 1			

ALL FIDUCIAL MARKERS ON THIS PAGE ARE CE MARKED

# Fiducial Markers









DISEASE SITE RECOMMENDATIONS

 HEAD & NECK
  BREAST
  LUNG
  ABDOMEN
  PROSTATE

## Align™

Align Markers are 10 mm long to accommodate localization software systems that utilize linear fiducials as opposed to multiple segment points.











MTNW887883	0.8 x 10 mm marker	18 GA ETW x 20 cm needle	Qty 2			
MTNW887881	1.2 x 10 mm marker	17 GA ETW x 20 cm needle	Qty 2			
MTNW887882	1.2 x 10 mm marker	17 GA ETW x 20 cm needle	Qty 3			

## CyberMark™

CyberMark Markers were developed specifically for use with Accuray's CyberKnife robotic radiosurgery system. The gold marker measures 5 mm long and 1 mm in diameter, as specified in the CyberKnife software.



MTNW887851	1 x 5 mm marker	18 GA ETW x 20 cm needle	Qty 1			
MTNW887853	1 x 5 mm marker	18 GA ETW x 20 cm needle	Qty 3			
MTNW887855	1 x 5 mm marker Loose, Sterile	-	Qty 4			

## Bone Markers

Bone Markers are 99.9% pure gold 2 mm spheres recommended for head and neck applications. They are typically placed in a small hole in the bone and sealed with bone wax, with minimal marker migration.



MTNW887805 NOT CE MARKED	2 mm diameter Loose, Sterile	-	Qty 3	
-----------------------------	---------------------------------	---	-------	---

## Suture-Type Markers

Suture-Type Markers are designed for high accuracy breast tumor localization. The 99.9% pure gold spheres with small central holes are readily sutured in place to provide a permanent localization solution. They are prethreaded on absorbable sutures.



MTNW887866	2 mm diameter	-	Qty 3	
------------	---------------	---	-------	---

ALL FIDUCIAL MARKERS ON THIS PAGE ARE CE MARKED UNLESS NOTED AS NOT CE MARKED



# Fiducial Markers

## DISEASE SITE RECOMMENDATIONS



### Gold Soft Tissue Markers

Gold Soft Tissue Markers are 99.9% pure gold cylinders specially knurled to inhibit migration. They are 3 mm long and 0.8, 0.9, 1.2 or 1.6 mm in diameter. They are available loose or in sterilized preloaded needles.



MTNW887871	0.9 x 3 mm marker	18 GA ETW x 12 cm needle	Qty 1			
MTNW887870	0.9 x 3 mm marker	18 GA ETW x 12 cm needle	Qty 3			
MTNW887872	0.9 x 3 mm marker	18 GA ETW x 20 cm needle	Qty 1			
MTNW887873	0.9 x 3 mm marker	18 GA ETW x 20 cm needle	Qty 3			
MTNW887830	1.2 x 3 mm marker	17 GA ETW x 20 cm needle	Qty 1			
MTNW887825	1.2 x 3 mm marker	17 GA ETW x 20 cm needle	Qty 3			
MTNW887840	1.2 x 3 mm marker	17 GA ETW x 20 cm needle	Qty 4			
MTNW887836	1.2 x 3 mm marker	17 GA ETW x 30 cm needle	Qty 1			
MTNW887835	1.2 x 3 mm marker	17 GA ETW x 30 cm needle	Qty 3			
MTNW887837	1.2 x 3 mm marker	17 GA ETW x 30 cm needle	Qty 4			
MTNW887860	1.6 x 3 mm marker	14 GA ETW x 20 cm needle	Qty 3			
MTNW887808	0.8 x 3 mm marker Loose, Sterile	-	Qty 3			
MTNW887809	0.9 x 3 mm marker Loose, Sterile	-	Qty 3			
MTNW887810	1.2 x 3 mm markers 10 mm spaced	17 GA ETW x 20 cm needle	Qty 1			
MTNW887812	1.2 x 3 mm marker Loose, Sterile	-	Qty 3			



ALL FIDUCIAL MARKERS ON THIS PAGE ARE CE MARKED

# Fiducial Markers

## DISEASE SITE RECOMMENDATIONS



### Accusyte **NEW**

The Accusyte 3D Fiducial Marking System marks the planes of a soft tissue cavity after a tumor has been removed. The fiducial sutures are used when soft tissue needs to be marked for future medical procedures, such as subsequent radiation therapy.

After a biopsy or tumor removal, the Accusyte fiducial sutures are sewn around the perimeter of the tumor bed at the anterior, posterior, middle, and lateral planes of the tumor cavity. The fiducials allow for accurate delineation of target volumes during treatment planning and assist with image guided radiation therapy (IGRT) before each session.

The fiducial markers are woven within an absorbable suture. When the body absorbs the suture, the fiducial markers remain within the tissue. Migration of the markers from their original position is unlikely, as the tissue produced during the healing process holds the markers in place.

Each package contains six sutures, which are sewn into place using the same technique as other sutures commonly used.

ONLY AVAILABLE IN THE U.S.



MTSRP104	Accusyte 3D Fiducial Marker Suture Set	1 x 4 mm	Qty 6 sets					
----------	--	----------	------------	--	--	--	--	--

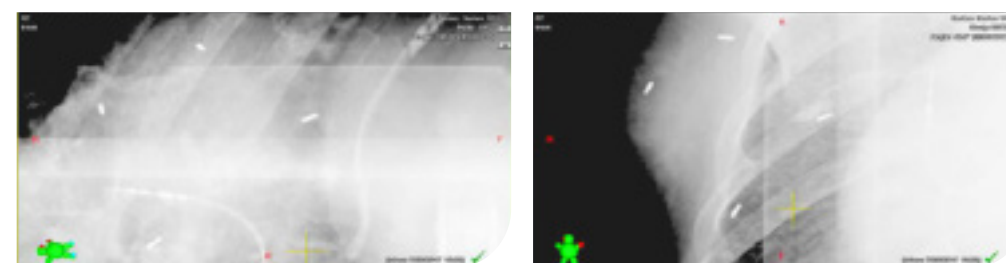

# Patient Marking

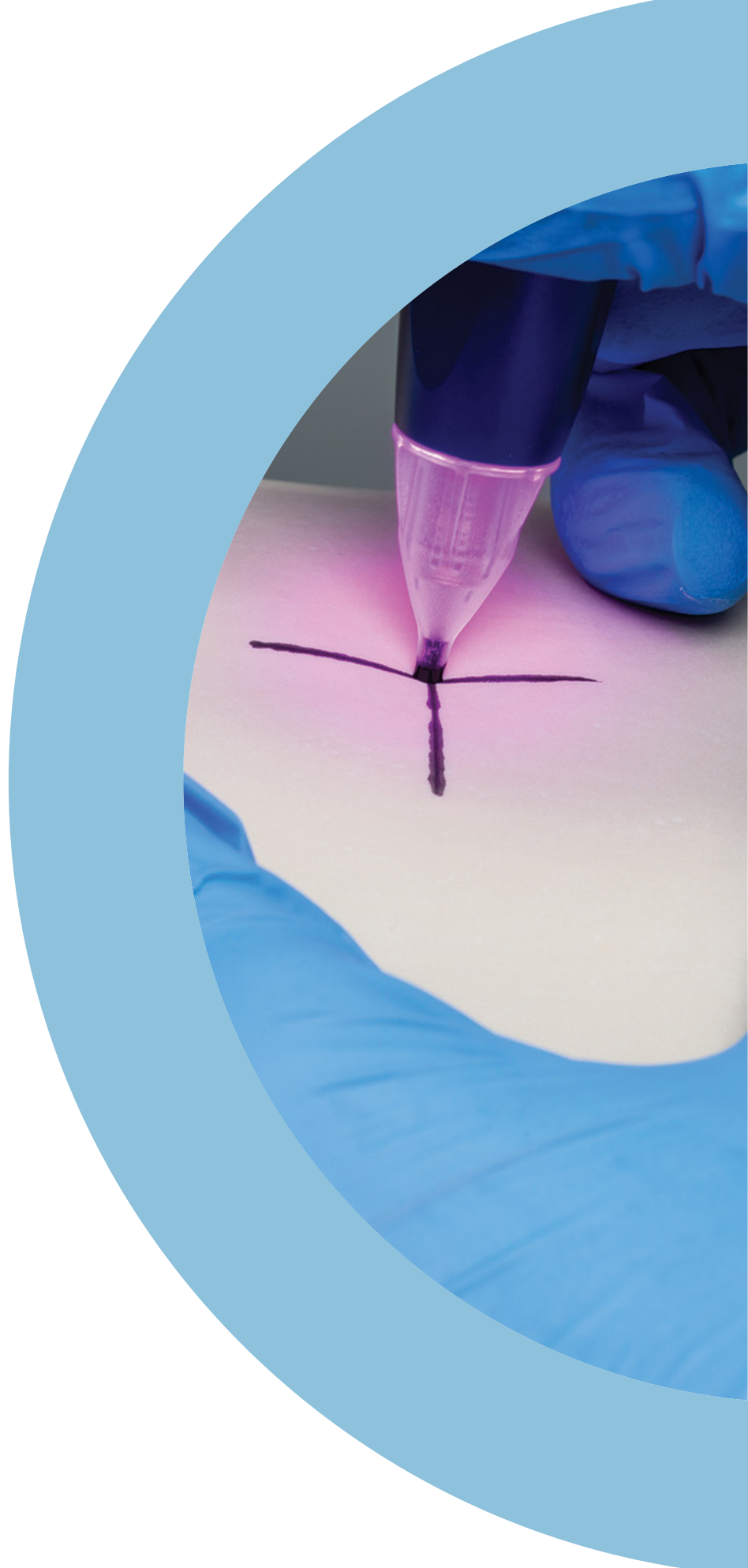

## Comfort Marker 2.0 Patient Marking System

Improve your patient's radiotherapy journey and gain clinical efficiencies with the Comfort Marker 2.0, developed by Medical Precision B.V. This revolutionary reference point device brings a new level of comfort to the start of the patient's radiotherapy treatment.

The easy-to-use system is designed specifically for use in radiotherapy using technology popular within the permanent make-up industry. The device is carefully engineered to apply reference marks with gentle and controlled depth placement, resulting in less painful tattooing to help keep the patient relaxed and cooperative throughout the process.

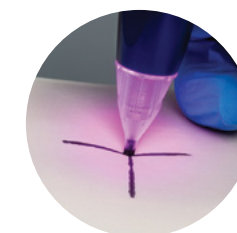

Medical Precision b.v.

### PATIENT BENEFITS

- Less painful tattooing keeps patients relaxed and more cooperative throughout the process
- Shallow and depth-controlled pigment placement compared to handheld lancets
- Result in cosmetically more pleasing tattoos that keep a round, uniform shape with well-defined edges

### CLINICIAN BENEFITS

- Sterile, easy to attach, and disposable safety needle module minimizes risks of needle stick accidents
- Simple depth setting selection with haptic and color feedback
- Rechargeable battery-powered device allows freedom of motion within CT room for medical professionals

### DEVICE BENEFITS

- Patients marked with Comfort Marker 2.0 reported less procedural pain than patients marked with lancets
- Physicians and radiation therapists doing photographic assessment of cosmesis rated Comfort Marker 2.0 better than lancets\*
- Radiation therapists rated placing tattoos with Comfort Marker 2.0 easier compared to the use of lancets

\*Limitation/additional information: study performed in Europe where majority of the population is Caucasian race, specific to Portugal where the study was performed the majority is from a Mediterranean ethnicity.



Safety Needle, Ink Cup, Pigment

### Comfort Marker 2.0

### CUSTOMERS OUTSIDE THE U.S.

### U.S. CUSTOMERS

Comfort Marker 2.0 System, Qty 1	MPCM2010INT	MPCM2010
Patient Marking Set. Includes: Safety Needle (Qty 50), Ink Cup (Qty 50), Black Pigment (Qty 50)	MPCM4022INT	MPCM4022

CE MARKED. FDA DE NOVO AND 510(K) CLEARED

# InkAlign™

Convenient, easy to use applicator to help regulate the flow of ink.

## MAXIMIZES PATIENT SAFETY

Each applicator device contains hypo-allergenic, sterile, non-toxic permanent ink that is safety sealed and gamma-irradiated; assuring sterility.

## DIFFERENTIATES NEW AREAS FROM PREVIOUS TREATMENT SITES

UV pink ink takes away the daily reminder of radiation. UV pink ink is visible under UV light allowing patients to not have unsightly marking tattoos. UV pink provides an alternative ink color to be used to identify different areas of treatment or differentiate new areas from previous treatment sites. UV pink can be used on all skin tones.

## EASY TO USE AND REPEATABLE

InkAlign is a sterile, single-use medical tattooing product with a pen-like design that provides standardized administration of radiation therapy tattooing. The ink applicator comfortably rests in the technician's hand for easy control of ink flow during application to skin.

InkAlign is available in packs of 25 sterile single-use devices with 21 gauge needles in UV pink or black ink. A box of 10 sterile single-use black ink droppers is also available (needles not included).

Available for sale in the USA and Canada. Contact sales for questions about other geographies.

THESE PRODUCTS HAVE NOT BEEN CE MARKED

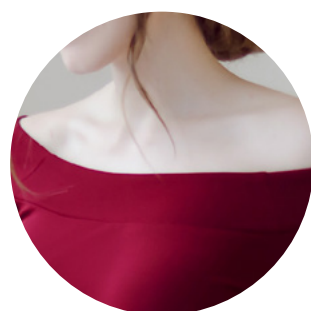

UV pink ink under natural light

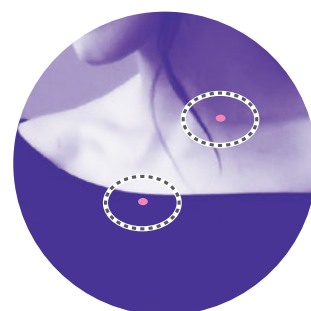

UV pink ink under UV Tattoo Light



Available in UV pink or black ink



UV Tattoo Light

RT-4426-OUVN	InkAlign, UV pink, Box of 25 Applicators*
RT-4426-OBKN	InkAlign, Black, Box of 25 Applicators*
RT-4426-DBK	InkAlign, Dropper, Black, Qty 10/Box
RT-4426-UVTL-02	UV Tattoo Light, 1" D x 3.5" H (25mm D x 89mm H)

\* Includes 21 gauge surgical grade, sterile hypodermic needles.

# Suremark™ Markers

## Suremark

Suremark markers are useful in distinguishing between a nipple shadow and lesion.

MTSL10 / RT-4421-SL10	ball size of 1.0 mm, Qty 110/Box
MTSL15 / RT-4421-SL15	ball size of 1.5 mm, Qty 110/Box
MTSL20 / RT-4421-SL20	ball size of 2.0 mm, Qty 110/Box
MTSL25 / RT-4421-SL25	ball size of 2.5 mm, Qty 110/Box



## Powermark™

Powermark markers maintain the advantages of Suremark markers and feature larger lead ball sizes for visibility in radiation therapy.

MTSL30 / RT-4421-SL30	ball size of 3.0 mm, Qty 50/Box
MTSL40 / RT-4421-SL40	ball size of 4.0 mm, Qty 50/Box
RT-4421-SL50	ball size of 5.0 mm, Qty 50/Box

## Suremark Wire

Suremark Wire is used for marking scar tissue, outlining palpable nodules, moles and entry points in CT scans.

MTSLW3 / RT-4421-SLW3	wire width of 0.3 mm, 336 cm
MTSLW4 / RT-4421-SLW4	wire width of 0.4 mm, 336 cm
MTSLW8 / RT-4421-SLW8	wire width of 0.8 mm, 336 cm
MTSLW12	wire width of 1.2 mm, 336 cm

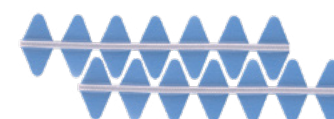

## Suremark Tabs

Suremark Tabs maintain the advantages of the Suremark markers with an added tabbed feature.

MTSL15T	1.5 mm, Qty 110/Box
MTSL20T	2.0 mm, Qty 110/Box





# Suremark Markers

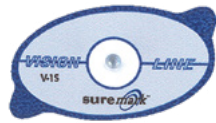

## Visionmark™

Visionmark markers are specially formulated non-metallic markers that perform consistently and accurately in a variety of applications. An excellent tool for distinguishing between nipple shadow and lesion, the Visionmark reduces the need for repeat examinations.

RT-4421-V20	ball size of 2.0 mm, Qty 110/Box
MTSLV25 / RT-4421-V25	ball size of 2.5 mm, Qty 110/Box
MTSLV30 / RT-4421-V30	ball size of 3.0 mm, Qty 50/Box
MTSLV40 / RT-4421-V40	ball size of 4.0 mm, Qty 50/Box
MTSLV50 / RT-4421-V50	ball size of 5.0 mm, Qty 50/Box

## CT Mark and CT Wire Mark

CT Mark new blue formulation is specifically designed for CT and will not cause artifact.

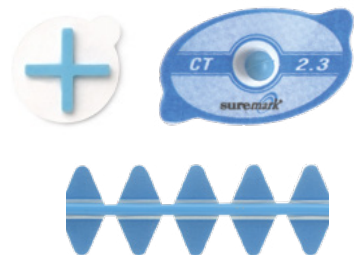

MTCT23 / RT-4421-CT23	ball size of 2.3 mm, Qty 110/Box
MTCT40 / RT-4421-CT40	ball size of 4.0 mm, Qty 50/Box
MTCTW10 / RT-4421-CTW10	1.0 mm line, 300 cm
MTCTW20 / RT-4421-CTW20	2.0 mm line, 300 cm
MTCTCR3	Cross, 1.2 cm, Qty 50/Box

# Suremark Markers



## Clearline™ Scar Markers

Clearline low-density scar markers provide distinct outlining of scars and other areas of concern without obscuring microcalcifications in mammography. These markers are non-metallic and are specifically formulated to eliminate scatter in CT applications.

RT-4421-CL10	semi-lucent lines of 1.0 mm, 336 cm
MTSLCL20 / RT-4421-CL20	semi-lucent lines of 2.0 mm, 320 cm
MTSLCL25	semi-lucent lines of 2.5 mm, 203 cm



## PortalMark™ Protective Label

In lieu of permanent or temporary tattoos, apply PortalMark labels to delineate radiation treatment areas. Their premium medical grade adhesive is hypo-allergenic and latex-free, resulting in less irritation for the patient. PortalMark labels are constructed of waterproof, yet breathable material for maximum performance and comfort for up to two weeks. Our unique Suregrip applicator discs ensure easy and accurate placement of PortalMark labels without contaminating the adhesive.

RT-4421-PM350	25 mm transparent label to delineate skin mark, Qty 110/Box
---------------	---

## Suremark Relief Tabs

Suremark Relief Tabs have a unique adhesive-free center that won't stick to sensitive areas of the skin.

MTSL25RT	2.5 mm, Qty 110/Box
----------	---------------------



## BeautyLine™ Labels

The updated design maintains all of the technical advantages of the regular Suremark labels including the tab feature. It is also produced with a soothing artistic flair to help take the edge off of stressful examinations for patients.

RT-4421-BL15	1.5 mm lead ball on BeautyLine Butterfly label, Qty 110/Box
--------------	---



# Suremark Markers

## LiquiMark™ MRI Markers

LiquiMark fiducial markers are non-metallic, latex-free, and perform consistently and accurately in a variety of applications. Qty 40/Box.



MTSLLM1 / RT-4421-LM1	8 mm round - for small field of view areas
MTSLLM2 / RT-4421-LM2	15 mm tube - for extremities, soft tissue, and breast
RT-4421-LM3	30 mm tube - for thoracic spines and larger areas of interest
RT-4421-LM4	10 mm square liqui-pouch - for orthopedic imaging and pediatric cases
RT-4421-LM5	10 mm x 24 mm liqui-pouch - for extremities, soft tissue and breast
RT-4421-LM6	10 mm x 38 mm liqui-pouch - for thoracic spines and larger areas of interest

# Additional Markers

## Disposable Rectal & Vaginal Markers

ShadowForm® Markers are used for simulation and CT planning. They are available in Rectal and Vaginal Markers; both have flexibility. They have a T-bar handle and can easily be removed for the optional insertion of barium.

- Materials promote patient comfort and provide ease of use
- Visible on any x-radiation modality
- Disposable, single use only

THESE PRODUCTS HAVE NOT BEEN CE MARKED

MTZM1710 / RT-4422-10RM	Disposable Rectal Marker, 10 cm long Qty 10/Box
MTZM1740 / RT-4422-38RM	Disposable Rectal Marker, 38 cm long Qty 10/Box
MTZM1735 / RT-4422-18VM	Disposable Vaginal Marker, 18 cm long Qty 10/Box



# Additional Markers

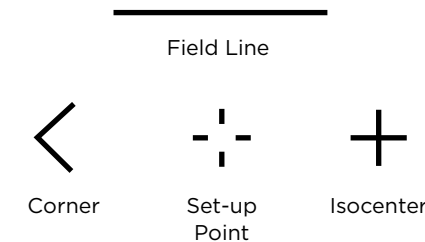

## Portal Markers

Set of marker tapes designed to outline the treatment field. This product is useful when planning multiple fields of treatment.

- Long lasting
- Comfortable
- Minimizes tattooing
- Water resistant

THESE PRODUCTS HAVE NOT BEEN CE MARKED

MTPM100	Standard, each sheet contains 8 field lines, 4 corners, 2 set-up points, 2 isocenters, 50 Sheets
MTPM150	Isocenter, 18 isocenters and 6 field lines, 50 Sheets

## DecoColor™ Markers

Oil-based paint markers that are acid-free, lead-free and non-toxic. Available in an assortment of colors.

(DecoColor markers are intended to be used for marking masks and shells, not for use in marking directly on skin.)



RT-4420-DCWT	Fine Line, White, Qty 12
RT-4420-DCBL	Fine Line, Blue, Qty 12
RT-4420-DCVT	Fine Line, Violet, Qty 12

## Sharpie® Markers

Fast-drying, acid-free ink that is ACMI certified non-toxic.

(Sharpie markers are intended to be used for marking masks and shells, not for use in marking directly on skin.)

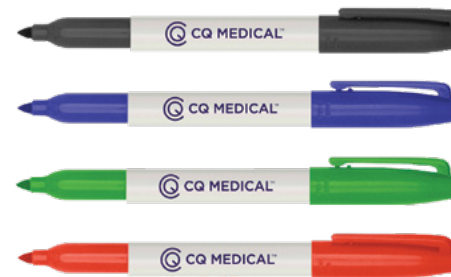

RT-4420-SPBK	Sharpie Marker, Fine Point, Black, Qty 1
RT-4420-SPBL	Sharpie Marker, Fine Point, Blue, Qty 1
RT-4420-SPGN	Sharpie Marker, Fine Point, Green, Qty 1
RT-4420-SPRD	Sharpie Marker, Fine Point, Red, Qty 1

## Setup Rulers

Great aid to help with the setup of patients. These rulers start at "0 mm" from the edge. For reference only.

CQRULER	Qty 1
---------	-------

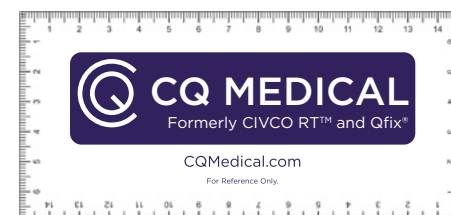

# MRSeries™

Always refer to product labeling to identify whether a device is MR Safe or MR Conditional.

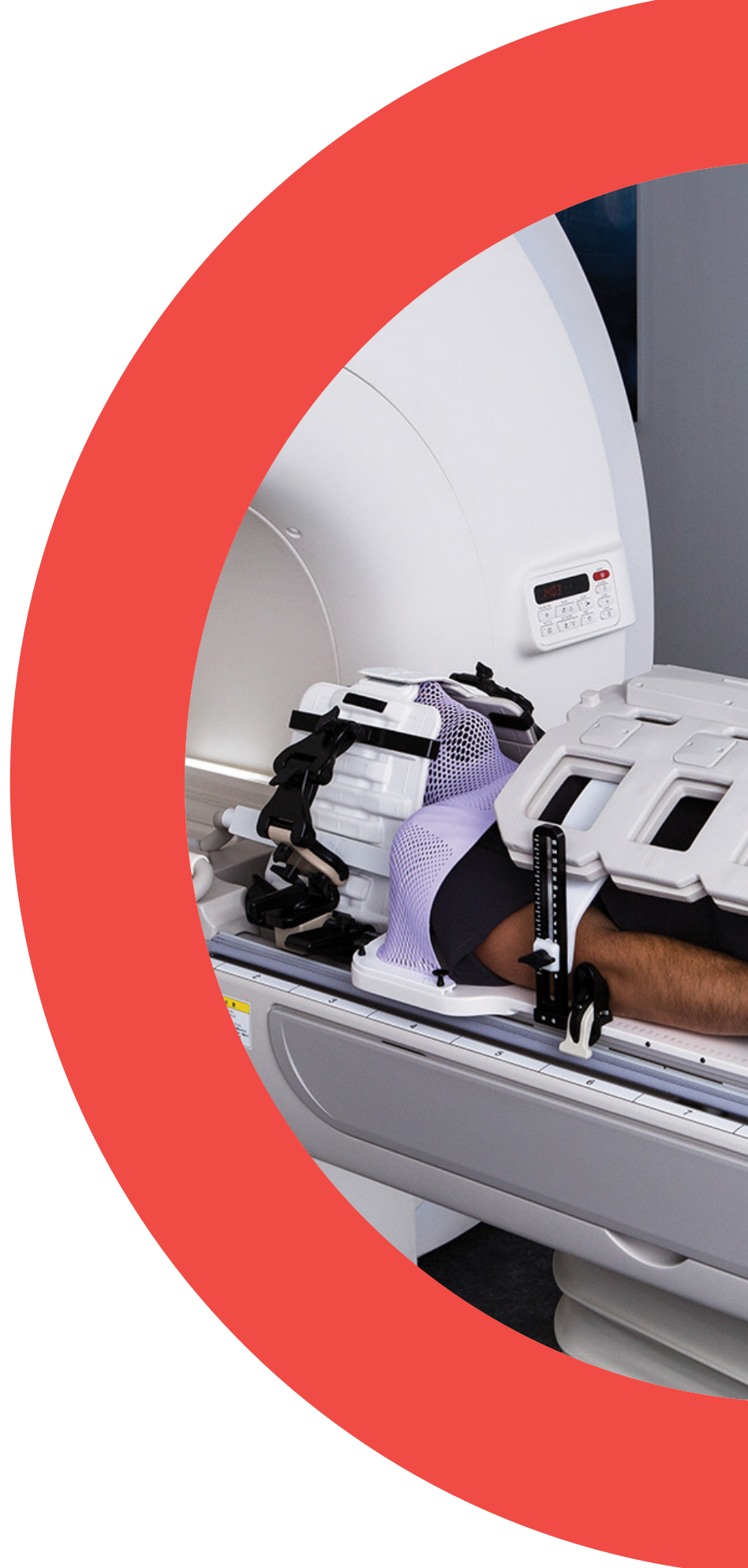

## Universal Couchtop MRI Overlays

Universal Couchtop MRI Overlays are made from fiberglass and feature Prodigy 2 indexing in 7 cm increments. Universal Couchtop is available on most major CT, MR, Proton and LINAC models to provide seamless transfer from imaging to treatment.

- Three-Pin Lok-Bar offers the option to use existing MR Safe or MR Conditional devices by indexing them to the overlay  
See pages 7-22 for additional information on Universal Couchtop.



UNIVERSAL COUCHTOP MRI OVERLAY FOR:	INDEXING STYLE	COMPATIBLE LOK-BAR	PART #
<b>SIEMENS</b>			
MAGNETOM Vida 3T (with Type-S & Posifix mask attachment)	Prodigy 2	MTIL6054	MTM3004
MAGNETOM Sola 1.5T (with Type-S & Posifix mask attachment)	Prodigy 2	MTIL6054	MTM3004
<b>CANON (FORMERLY TOSHIBA)</b>			
Vantage Galan 3T	Prodigy 2	MTIL6054	-
Vantage Orian 1.5T	Prodigy 2	MTIL6054	-

Contact Canon Medical for more information

### Three-Pin Lok-Bar

Three-Pin Lok-Bars allow you to index MR Safe or Conditional devices to your MRI overlay.

MTIL3351	Interloc 50 cm
MTIL3352	Interloc 53 cm
MTIL3454	Prodigy 50 cm
MTIL6054	Prodigy 2, 53 cm

### Elekta Unity MR-LINAC Three-Pin Lok-Bar

Allow the use of MRSeries positioning devices

MTULB001	Three-Pin compatible
MTULB002	QA Lok-Bar, contains spacer support for a stable and consistent base

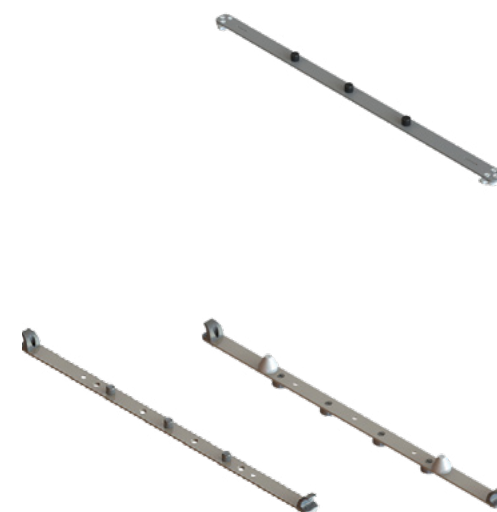



# Alta Multipurpose Device

## ELEVATE YOUR WORKFLOW

Alta is an all in one solution that quickly adapts to a wide range of setups, for a more user friendly and ergonomic experience.

- Combines functionality of multiple devices
- Dependable and reproducible
- Fast and efficient setups
- Can be extended beyond end of couchtop for improved head and neck dosimetry
- Lightweight—5.4 kg (12 lbs)
- MR Safe, CT and treatment compatible

See pages 36–38 for more details.

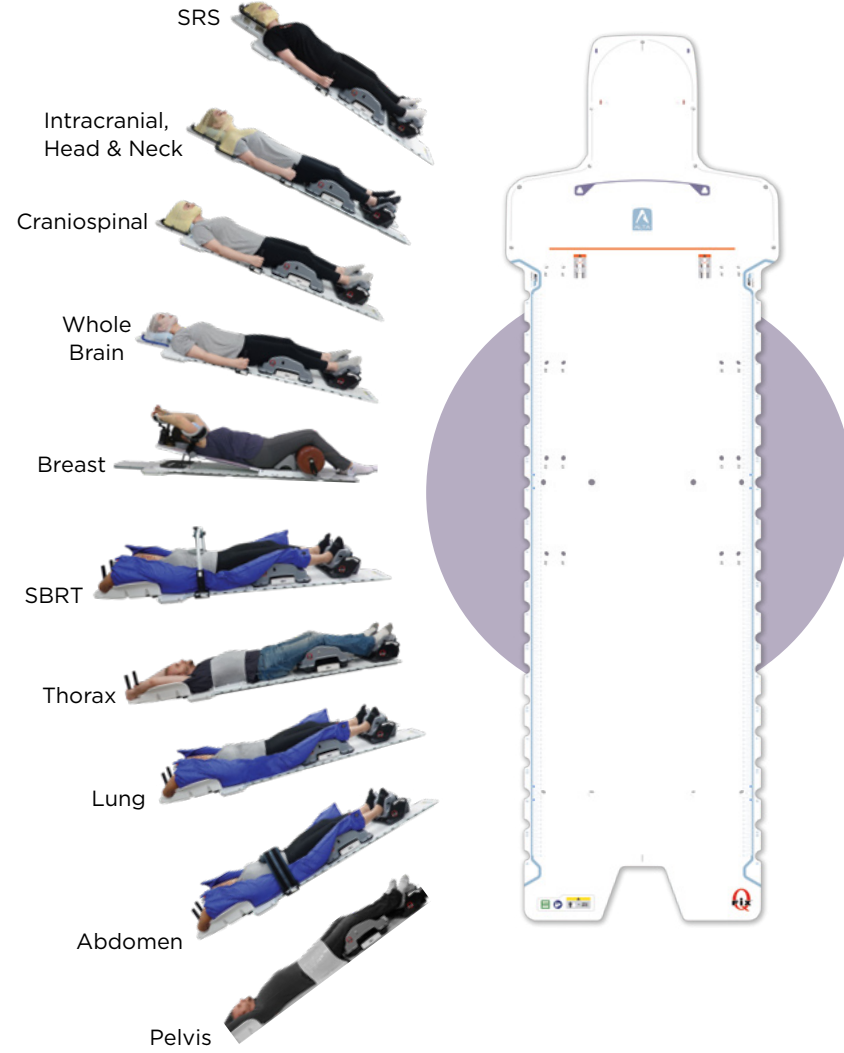

# Overlays

MRI overlays are made of fiberglass with a foam core, have Prodigy and Interloc indexing options and are compatible with a three-pin Lok-Bar. Three-Pin Lok-Bars allow MR Safe and MR Conditional devices to be indexed to an MRI Overlay.



MRI OVERLAY FOR:	INDEXING STYLE	COMPATIBLE LOK-BAR	PART #
<b>PHILIPS</b>			
Panorama, 40 cm Wide (Only available from Philips)	Prodigy	MTIL3455 (2 included)	<b>MTM3401</b>
Ingenia Ambition, Ingenia Elition	Interloc	MTIL3352 (2 included)	<b>MTM3404</b>
<b>GE</b>			
Wide Bore (750w or 450w) with GEM	Interloc	MTIL3352 (1 included)	<b>MTM3302</b>
<b>SIEMENS</b>			
Magnetom Avanto, Magnetom Espree, Magnetom Symphony A Tim System, Magnetom Trio A Tim System	Prodigy	MTIL3454 (1 included)	<b>MTM3000</b>
Magnetom Verio	Prodigy	MTIL3454 (1 included)	<b>MTM3001</b>
Aera, Skyra, Vida, Prisma (with Type-S mask attachment)	Prodigy	MTIL3454 (1 included)	<b>MTM3002</b>
Aera, Skyra, Vida, Prisma (with Posifix mask attachment)	Prodigy	MTIL3454 (1 included)	<b>MTM3003</b>

# TotalRT All in One Platform

The TotalRT All in One Platform is designed to quickly adapt positioning and immobilization solutions to your clinical setup and treatment needs. The platform is indexable on a couchtop, creating an affordable all in one solution and allowing seamless transition between patient treatments.

See pages 39–40 for more details.



# INSIGHT MR Overlay & Coil Holders

## INSIGHT

INSIGHT MR Overlay and Coil Holders are designed to enable MR imaging in the same position as treatment. Its thin design positions the patients closer to the scanner coils for improved MR imaging.

## INSIGHT MR OVERLAY

Mounts to compatible Siemens MAGNETOM Aera, Skyra, Vida, and Sola tables allowing the use of MR compatible patient positioning devices during MR scanning for radiotherapy. The INSIGHT MR Overlay is compatible with Portrait head only Type-S thermoplastic masks.

## INSIGHT MR COIL HOLDERS

Intended to position coils for head and body imaging with the patient in the desired treatment position. Coil holders are available for Siemens MAGNETOM Aera, Skyra, Vida, and Sola scanners using the Flex 4, Body 6, and Body 18 coils. Please contact us for more details on compatibility with Siemens MR Systems.

**NOW COMPATIBLE WITH HEAD & SHOULDER MASK**

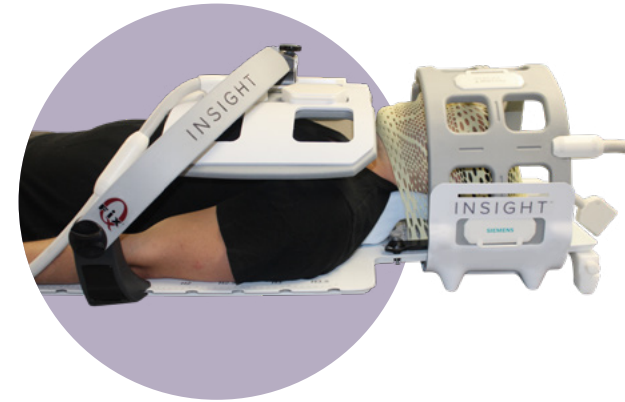

## MR Overlay & Coil Holders Package

RT-4700-10

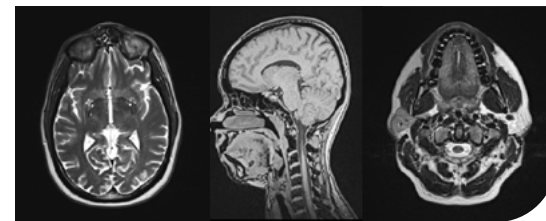

MR images of a healthy volunteer

# Encompass 15-Channel Head Coil for MR Imaging

## OPTIMIZED FOR USE WITH THE ENCOMPASS MR SRS IMMOBILIZATION SYSTEM

The Encompass 15-Channel Head Coil is specially designed to accommodate the high-precision positioning unique to the Encompass MR SRS Immobilization System.

The adjustable coil geometry locates the coil elements within millimeters of each patient's unique anatomy providing an optimized signal-to-noise ratio and delivering imaging information to support accurate SRS treatment planning when used with the Encompass MR SRS Immobilization System.

Immobilization in the Encompass SRS System offers motion reduction for increased visualization of fine details, reducing the need for repeated scans. MR images obtained with the Encompass SRS System can be used for SRS treatment planning, including MR-Only and MR Fusion Techniques.

Please note: Encompass Coil is used with the Encompass MR Device for Imaging Only. Encompass Coil is not for Treatment. The Encompass Device can be used for both imaging and treatment.

RT-5200-01 Encompass 15-Channel Head Coil



  
Encompass® Coil

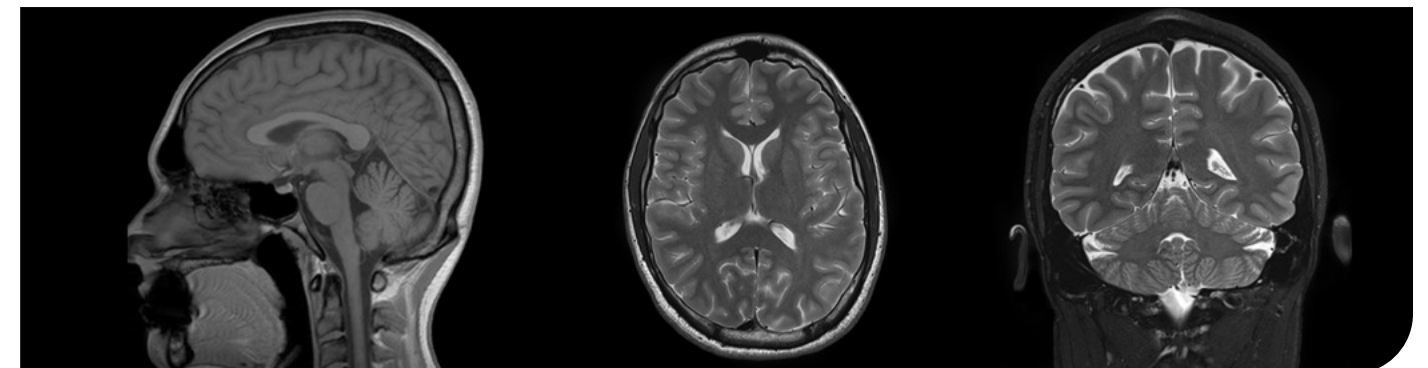



# MRSeries Positioning Devices

## HEAD & NECK



**Solstat  
Immobilization System**  
Page 102



**Portrait MR Head  
& Neck Device**  
Page 79



**MRI Type-S Overlay**  
Page 80



**ProForm MR Overlay**  
Page 193  
**BoS MR Headframe**  
Page 199

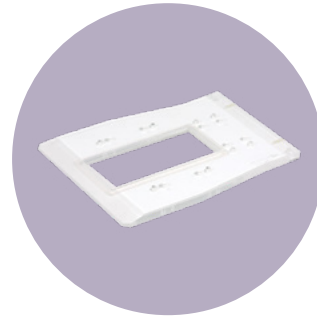

**Acrylic Baseplates**  
Uni-frame 90  
Posifix 95



**Polycarbonate  
Headboard**  
89



**Thermoplastics**  
Type-S Pages 82-88  
Uni-frame Pages 91-93  
Posifix Pages 96-98  
Pediatric Page 101  
Precise Bite Page 105

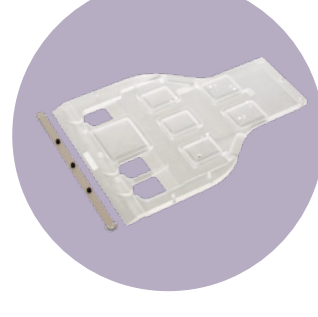

**M.C.Inspire Baseplate  
compatible with  
MRIdian by ViewRay**  
Page 103



**Customizable  
Head Support**  
Page 104  
**AccuForm Cushions**  
Page 107



**Headrests**  
Pages 109-114

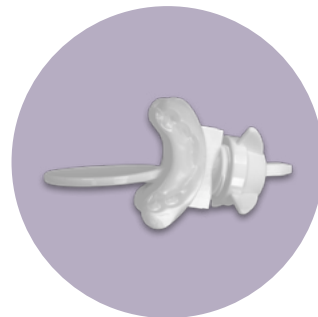

**GrayDuck Oral  
Positioning Stents**  
Page 106

# MRSeries Positioning Devices

## SRS/SRT



**Encompass SRS MR  
Head & Neck Device**  
Page 60



**Solstice MR SRS  
Immobilization System**  
Page 64

## SBRT, LUNG & ABDOMEN

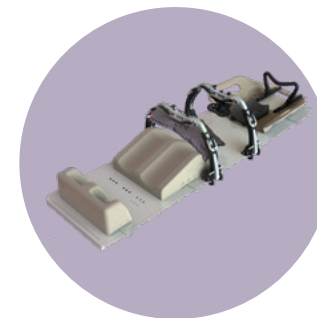

**Body Pro-Lok ONE**  
Page 46

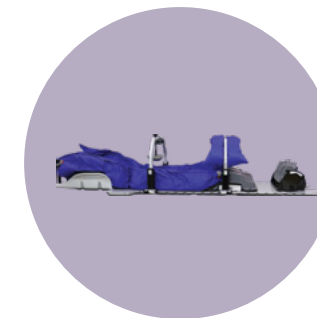

**Alta SBRT Immobilization**  
Page 51



**ZiFix Traverse**  
Page 52



**ZiFix**  
Page 54

## BREAST & THORAX



**C-Qual M  
Breastboard**  
Page 122

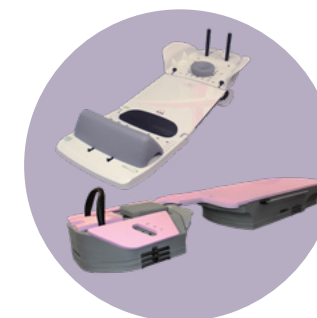

**Access Supine MR Breast  
& Lung Treatment Device**  
Page 125



**Evolve  
Breastboard**  
Page 129



**Wing Boards**  
Pages 123 & 136

**Access Prone G2  
Breast Device**  
Page 133



# MRSeries Positioning Devices

## HIP & PELVIS



**ThermFix & HipFix  
Immobilization Systems**  
Page 140



**FlexLock Knee &  
Foot Supports**  
Page 144



**Combifix 3**  
Page 145



**MR Bellyboard**  
Page 145  
**SofTouch Elite Bellyboard**  
Page 146

## PATIENT CUSHIONS & POSITIONING AIDS



**Kneefix 3  
& Feetfix 3**  
Page 148



**Vac-Lok and  
VacQfix Cushions**  
Pages 152-159

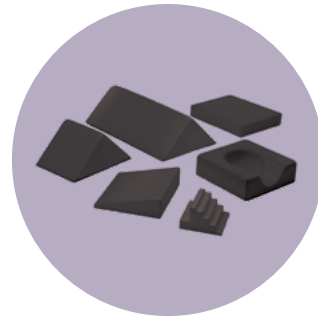

**Multipurpose  
Support Cushions**  
163



**SofTouch Couchtop Pads**  
24

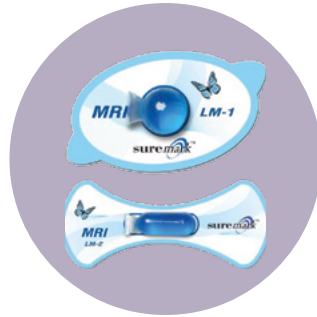

**LiquiMark MRI  
Markers**  
177

# ProtonSeries®



# CHOOSING A PROTON HEAD & NECK POSITIONING SYSTEM\*

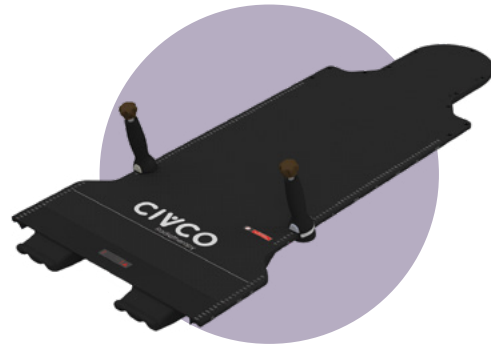

## ProForm™

The ProForm system is our most recent proton innovation. This solution provides an easy to use mask attachment and a homogenous treatment region optimized for CNS patients.

Pages 193-195

## Pediatric ProForm

Pediatric ProForm compliments the adult ProForm solution and provides a solution fully optimized for positioning your pediatric patients.

Pages 196-197

<b>COUCHTOP COMPATIBILITY</b>	Universal Couchtop	Universal Couchtop
<b>EXTENSION OR INSERT OPTION</b>	Yes, multiple lengths	Yes
<b>INDEXING STYLE</b>	Prodigy 2	Prodigy 2
<b>CT OVERLAY OPTION</b>	Yes	Yes
<b>MR OVERLAY OPTION</b>	Yes	Yes
<b>THERMOPLASTIC MATERIAL</b>	Aquaplast RT	Aquaplast RT
<b>THERMOPLASTIC SPECIAL FEATURES</b>	Pre-cut eye and mouth, Open-face, Reinforced, Hair opening, Solid	Pre-cut eye and mouth, Open-face, Reinforced
<b>POSTERIOR HEAD SUPPORT</b>	Customizable Cushion	Customizable Cushion
<b>SHIM OPTION</b>	AccuForm Shim	AccuForm Shim

\*These devices offer many configurations and compatibilities. Please consult your sales representative for more information.



## BoS® Headframe

The BoS system's conformal shape provides optimal treatment beam angles and has become a standard for head & neck immobilization in proton therapy over the last 15 years.

Pages 200-201

## Portrait™ Proton

The Portrait proton system provides a complimentary head & neck solution for your kVue couchtops. The simple, easy to use design is compatible with Type-S thermoplastic masks.

Page 203

kVue	kVue
Yes, multiple lengths	Yes
Varian Exact	Varian Exact
Yes	Yes
Yes	Yes
Fibreplast and Aquaplast RT	Fibreplast and Aquaplast RT
Open-face, Hair opening, Cranial flap	Open-face, Pre-cut eye and mouth, Variable Perf pattern
Foam Headrest, Customizable Cushion	Silverman, Customizable Cushion
Precut Foam Shim	Integrated in Frame, 0.5 mm increments

# Universal Couchtop Long Extension

The Universal Couchtop is a modern and comprehensive solution for enabling advanced treatments in your clinic. Specifically designed to answer the demands of Proton, the Universal Couchtop Long Extension contains no rails or junctions in the treatment area to help facilitate better dose delivery and target coverage.

- Homogenous design for consistent treatment planning
- Utilizes Prodigy 2 indexing at 7 cm increments
- Low attenuation and surface dose
- Self-locking extension seam located outside of treatment field
- Compatible with many positioning and immobilization devices (see page 204)
- 5 Year Warranty



## IBA Systems Proteus® ONE and Proteus PLUS

Includes Rectangular Extension (MTIL6673) and Prodigy 2 Lok-Bar. Large treatment area of 58.9" (149.7 cm).

MTIL6840	F-Series
MTIL6841	L-Series

## Mevion Medical Systems S250™ Series

Includes Rectangular Extension (MTIL6660) and Prodigy 2 Lok-Bar. Large treatment area of 47.1" (119.7 cm).

MTIL7040	S250 Series
----------	-------------

## Hitachi Ltd.

Compatible solutions available. Contact Hitachi for information.

## Rectangular Extension

MTIL6673	64.9" (164.8 cm), square profile
MTIL6676	64.9" (164.8 cm), CT compatible
MTIL6660	53.1" (134.9 cm), standard profile
MTIL6684	53.1" (134.9 cm), square profile

See page 10 for LINAC and CT compatible Universal Couchtops



**A universal platform for immobilization & positioning**



# ProForm Head & Neck Immobilization

The Universal Couchtop ProForm Head & Neck Extension features geometry that allows for direct access to effectively treat CNS patients. ProForm accepts a dedicated thermoplastic mask designed to meet the unique requirements of proton therapy.

- Homogeneous treatment area and soft gradient edges reduce beam degradation
- Head & Neck area provides fixed points that allow repeatable positioning and security of the AccuForm Cushion
- Thermoplastic mask attaches with a smaller profile frame and pin similar to the Type-S system



## Extensions

MTIL6675K	ProForm Head & Neck Extension, 53.9" (136.9 cm), includes Cushion Guide and UCT Patient Handles
MTIL6683K	ProForm Head & Neck Extension, 64.9" (164.9 cm), includes Cushion Guide and UCT Patient Handles
MTIL6682K	Pediatric ProForm Head & Neck Extension, 48.7" (123.7 cm), includes Cushion Guide and UCT Patient Handles

Additional ProForm Extension lengths are available. Contact your sales representative for more information.

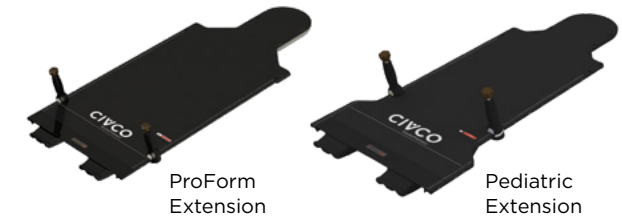

## Overlays

The ProForm CT & Photon Treatment Overlay and MR Overlay allow for CT simulation or MR imaging of patients who will be treated on the Universal Couchtop ProForm Extension, allowing seamless transition from simulation to treatment.

PRO300K	ProForm CT & Photon Treatment Overlay, 2-Pin Lok-Bar compatible, includes ProForm Cushion Guide, Patient Handles and Table Strap
PRO320K	ProForm MR Overlay, 3-Pin Lok-Bar compatible, includes Cushion Guide and Patient Handles
PRO400K	Pediatric ProForm CT & Photon Treatment Overlay, 2-Pin Lok-Bar compatible, includes ProForm Cushion Guide and Patient Handles
PRO420K	Pediatric ProForm MR Overlay, 3-Pin Lok-Bar compatible, includes ProForm Cushion Guide and Patient Handles

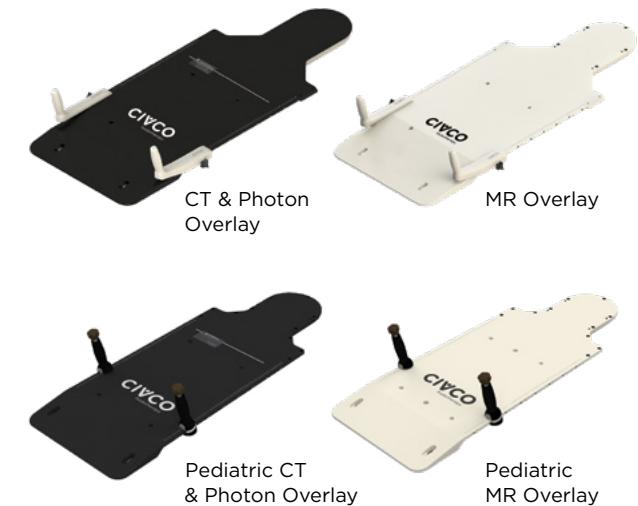



# ProForm Thermoplastic

Masks are sold in boxes of 5 and are disposable. ProForm Thermoplastics are made from Aquaplast RT material.

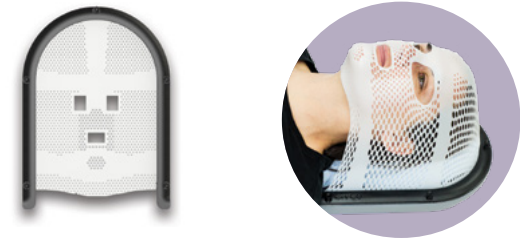

## FreedomView Reinforced Style 18

PRO330IM1832CL	Head Only, 3.2 mm
PRO331IM1832CL	Head, Neck & Shoulders, 3.2 mm
PRO331IM1832CLN	Head, Neck & Shoulders, Narrow



## ClearVision 2

PRO330IM1832SG	Head Only, 3.2 mm
PRO331IM1832S	Head, Neck & Shoulders, 3.2 mm
PRO331IM1832SGN	Head, Neck & Shoulders, Narrow



## Shoulder Thermoplastic Docking

Two shoulder docking options are available; standard top docking and underneath docking to accommodate for larger patients where additional stretching of thermoplastic may be required.

Not available for pediatric.



# ProForm Thermoplastic

Masks are sold in boxes of 5 and are disposable. ProForm Thermoplastics are made from Aquaplast RT material.



## Reinforced Style 18

PRO330IM1832	Head Only, 3.2 mm
PRO331IM1832	Head, Neck & Shoulders, 3.2 mm
PRO331IM1832N	Head, Neck & Shoulders, Narrow

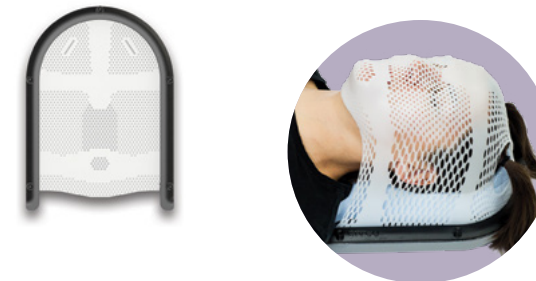
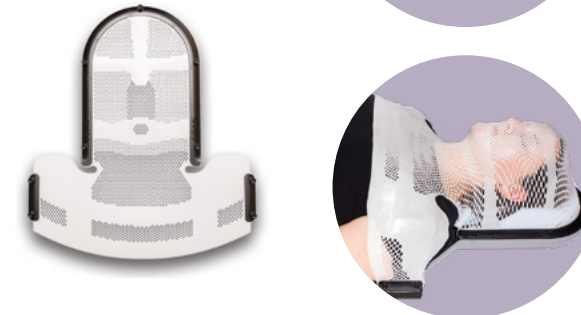

## Reinforced Style 18 with Hair Openings

PRO330IM1832PT	Head Only, 3.2 mm
----------------	-------------------

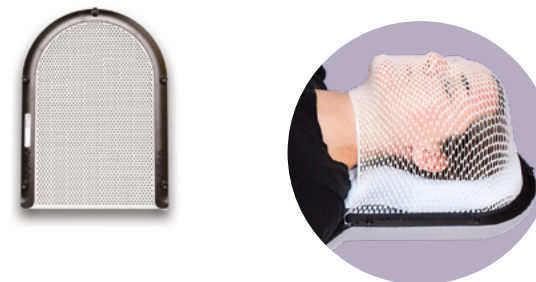

## Standard Perforated

PRO330	Head Only, 3.2 mm
--------	-------------------



## Solid With Perforated Nose

PRO330SPN32	Head Only, 3.2 mm
-------------	-------------------



## Registration Film

PRO340	Qty 5
--------	-------

## AccuForm Cushion

MTACL2035	20 x 35 cm Chamfered, Qty 1
-----------	-----------------------------

# Pediatric ProForm Thermoplastics

Masks are sold in boxes of 5 and are disposable. ProForm Thermoplastics are made from Aquaplast RT material.



## FreedomView Reinforced Style 18

**PRO430IM1832CL** Pediatric Head Only, 3.2 mm

**PRO431IM1832CL** Pediatric Head, Neck & Shoulders, 3.2 mm



## ClearVision 2

**PRO430IM1832SG** Pediatric Head Only, 3.2 mm

**PRO431IM1832SG** Pediatric Head, Neck & Shoulders, 3.2 mm



# Pediatric ProForm Thermoplastics

Masks are sold in boxes of 5 and are disposable. ProForm Thermoplastics are made from Aquaplast RT material.



## Reinforced Style 18

**PRO430IM1832** Pediatric Head Only, 3.2 mm

**PRO431IM1832** Pediatric Head, Neck & Shoulders, 3.2 mm



## Standard Perforated

**PRO430** Pediatric Head Only, 3.2 mm

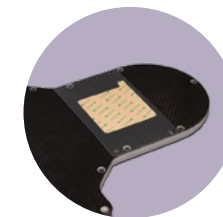

## Registration Film

**PRO440** Pediatric, Qty 5



## AccuForm Cushion

**MTACL2035** 20 x 35 cm Chamfered, Qty 1

# kVue One Proton Couchtop

The kVue One Proton Couchtop is rigid, lightweight and specifically designed for use with a robotic couch, which is frequently used in proton therapy applications. The versatile kVue platform provides a wide range of positioning and immobilization options for treating tumors of varying complexities.

The expansive array of kVue inserts provide clinicians the flexibility to develop and manage treatments that are best suited for a patient's specific treatment needs. All kVue inserts are easily adapted to a variety of radiotherapy treatments in one simple solution.

- Specifically designed to provide range shift confidence for proton therapy
- Interchangeable inserts for full range of proton therapy treatments
- For use with a robotic couch

**RT-4551KV-03** kVue One Proton Couchtop

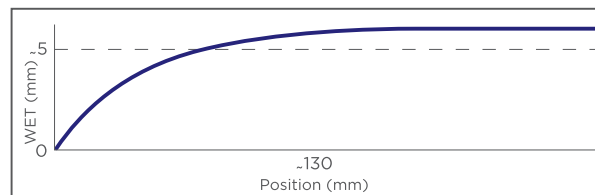
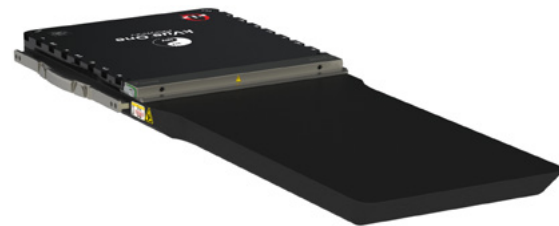
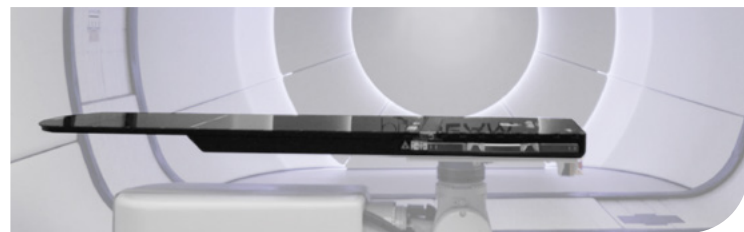

Typical kVue One Proton Water Equivalence Profile

# kVue Proton Couchtop

The kVue Proton Couchtop is specifically designed for use with robotic couches.

MANY KVUE STANDARD INSERT OPTIONS ARE AVAILABLE. CONTACT YOUR SALES REPRESENTATIVE FOR MORE INFORMATION.



# kVue BoS Proton System

## BoS Inserts

kVue BoS inserts are specifically designed to meet the unique requirements of proton therapy for patient immobilization and beam transmission. The BoS device is engineered to rigidly support the patient without using a flat base that blocks the use of important proton beam angles.

The conformal shape is designed to minimize the distance between the patient and the field defining aperture, optimizing the beam proton penumbra.

kVue BoS inserts are available in two additional lengths. The shorter version which is required to treat vertex fields in some robotic couch setups and a longer version that is required to treat lower spinal fields on tall patients.

<b>RT-4535KV</b>	Standard length, 132 cm
<b>RT-4535KV01</b>	Shorter length, 121 cm
<b>RT-4535KV03</b>	Longer length, 158 cm

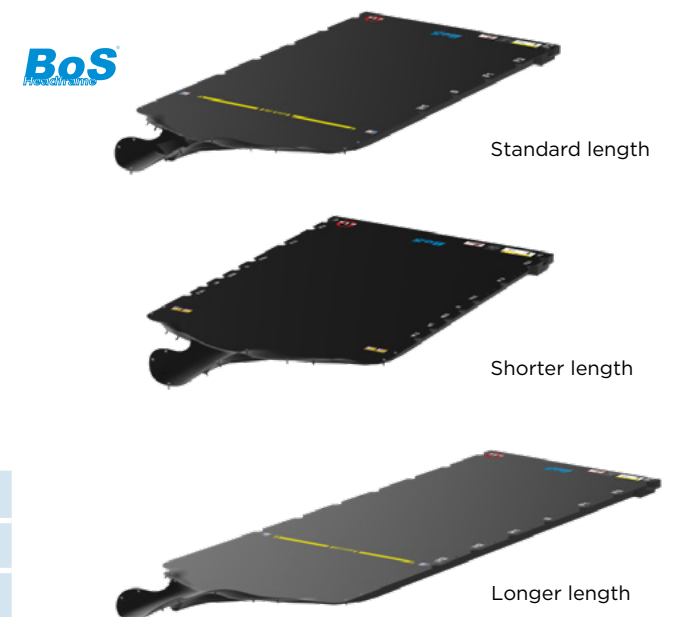

## BoS Headframes

The BoS Headframe is engineered to rigidly support the patient without using a flat base that blocks the use of important proton beam angles. The BoS MR Headframe enables enhanced imaging in both CT and MR while also facilitating the use of CT fusion techniques.

<b>RT-4535BOSMRI</b>	BoS MR Headframe
<b>RT-4535BOS</b>	BoS Headframe

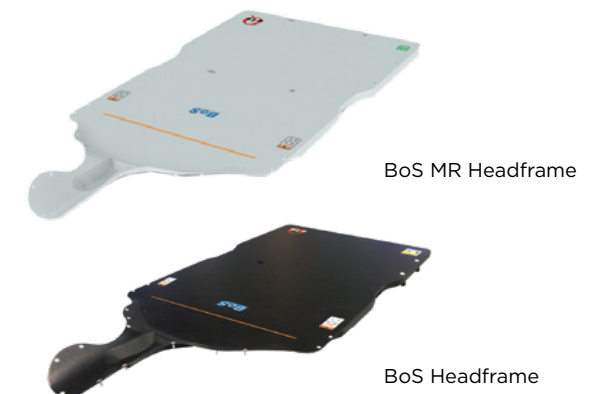

## BoS Accessories

<b>RT-4490BOS1</b>	Foam Headrest, Qty 1
<b>RT-4485</b>	Precut Foam Shim for BoS Headframe, Qty 1
<b>RT-4525HGA</b>	Hand Grips, Pair
<b>RT-4492U</b>	AccuForm U Head Cushion, 20 x 35 cm





# BoS Thermoplastics

Masks on this page are disposable and sold in Qty 1. Must purchase in multiples of 10.

The innovative 3D shape matches the contour of the BoS device, which is designed to meet the unique requirements of proton therapy for patient immobilization and beam transmission. These masks come in a variety of different options, allowing for head and neck as well as head and shoulder immobilization.



## Head & Neck, 24 cm wide for smaller patients

RT-1782BOS-DXS	Aquaplast RT (Extra Small), Standard Perf, 2.4 mm
RT-1882KBOS-DXS	Fibreplast (Extra Small), Standard Perf, 3.2 mm

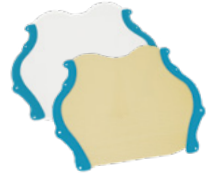

## Head & Neck, 26 cm wide, 3.2 mm

RT-1878BOS-D2LVS	Aquaplast RT, Micro Perf with Cranial Flap
RT-1878KBOS-D2LVS	Fibreplast, Micro Perf with Cranial Flap
RT-1882BOS-DVS	Aquaplast RT, Standard Perf
RT-1882KBOS-DVS	Fibreplast, Standard Perf



## Head & Neck, Head & Shoulders, 3.2 mm

RT-1878KBOS-D2LSF	Assure™ Open View Fibreplast Head & Neck, Micro Perf with Cranial Flap, 31 cm wide
RT-1878KBOS-E2LF	Assure Open View Fibreplast Head & Shoulders, Micro Perf with Cranial Flap, 43 cm wide



# BoS Thermoplastics

Masks on this page are disposable and sold in Qty 1. Must purchase in multiples of 5.

## Head & Neck, 31 cm wide, 3.2 mm

RT-1878BOS-D2LS	Aquaplast RT, Micro Perf with Cranial Flap
RT-1878KBOS-D2LS	Fibreplast, Micro Perf with Cranial Flap
RT-1882BOS-DS	Aquaplast RT, Standard Perf
RT-1882KBOS-DS	Fibreplast, Standard Perf

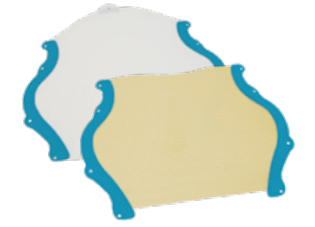

## Head & Neck, 38 cm wide, 3.2 mm

RT-1878BOS-D2L	Aquaplast RT, Micro Perf with Cranial Flap
RT-1878KBOS-D2L	Fibreplast, Micro Perf with Cranial Flap
RT-1882BOS-D	Aquaplast RT, Standard Perf
RT-1882KBOS-D	Fibreplast, Standard Perf

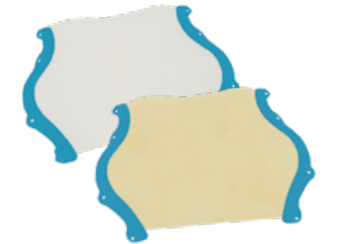

## Head & Shoulders, 43 cm wide, 3.2 mm

RT-1878BOS-E2LS	Aquaplast RT (Small), Micro Perf with Cranial Flap
RT-1878KBOS-E2LS	Fibreplast (Small), Micro Perf with Cranial Flap
RT-1882BOS-ES	Aquaplast RT (Small), Standard Perf
RT-1882KBOS-ES	Fibreplast (Small), Standard Perf

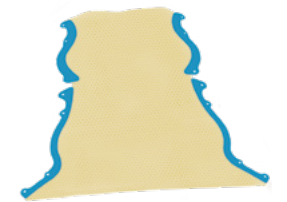

## Head & Shoulders, 48 cm wide, 3.2 mm

RT-1878BOS-E2L	Aquaplast RT, Micro Perf with Cranial Flap
RT-1878KBOS-E2L	Fibreplast, Micro Perf with Cranial Flap
RT-1882BOS-E	Aquaplast RT, Standard Perf
RT-1882KBOS-E	Fibreplast, Standard Perf

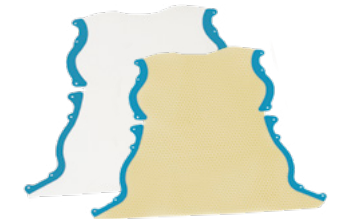

Measurement is taken at thermoplastics maximum width.

# BoS AirShuttle for use with Symphony AirDrive System

A Symphony solution combines an AirShuttle positioning & transfer device with an AirDrive system to provide smooth patient transfers for imaging and treatment applications. Designed for proton therapy, the conformal shape of the BoS AirShuttle optimizes the penumbra and minimizes the blockage of important proton beam angles. When utilized alongside the Symphony AirDrive System, it facilitates seamless patient transfers for imaging and treatment procedures.

- Safely transfer your patient with minimal clinical staff
- Transfer on and off a wide variety of surfaces including sheet-covered pads and mattresses
- Patient positioning can include immobilization, where required
- Suitable for use in MRI
- Designed for proton therapy, the conformal shape of the device optimizes the penumbra and minimizes the blockage of important proton beam angles

See page 29 for AirDrive Systems

**RT-5100-04** BoS AirShuttle



BoS® AirShuttle



AirDrive Trolley



AirDrive Caddie

## BoS AirShuttle Packages

Both packages include: AirShuttle Transfer Handles (x2), AirShuttle Locating Bars (x2), BoS Air Bearing (Spare)

**RT-5100-400** w/ AirDrive Trolley

**RT-5100-400S** w/ AirDrive Caddie



# kVue Portrait Proton System

## Portrait Proton Insert

The kVue Portrait Proton insert is ideal for proton craniospinal radiotherapy treatments where whole brain lateral fields are combined with PA spine fields.

- Homogeneous, carbon fiber design provides constant WET from cranium to sacrum
- Compatible with Type-S Head Only and Head and Shoulder thermoplastic masks (see pages 82-88)

**RT-4552KV-01** Portrait Proton Insert



## Portrait Accessory

**RT-4525HGA** Hand Grips, Pair

**RT-4492U** AccuForm U Head Cushion, 20 x 35 cm, Qty 1

**See page 102** Silverman Head Support Q Series

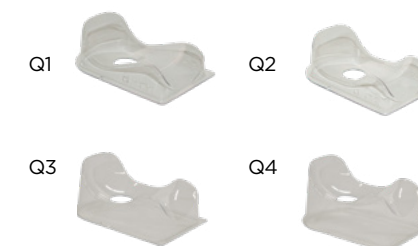

# Additional ProtonSeries Positioning Devices

## HEAD & NECK

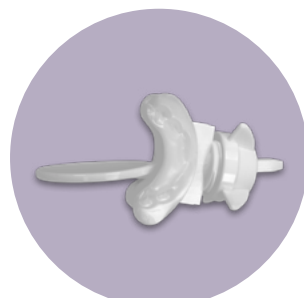

GrayDuck  
Oral Positioning  
Stents  
Page 106

## BREAST & THORAX



C-Qual M with  
Monarch Overhead  
Arm Positioner  
Page 122

## LUNG & ABDOMEN



Body Pro-Lok ONE  
Respiratory Belt  
Page 45

## HIP & PELVIS



Combifix 3  
Page 145

## PATIENT CUSHIONS



Vac-Lok Cushions  
Pages 152  
& 153

## FIDUCIAL MARKERS



PolyMark and  
PointCoil  
Page 167

## UCT ACCESSORIES



Universal Couchtop  
Patient Handles  
Page 25

# Accessories, Aids & Storage





# Bolus

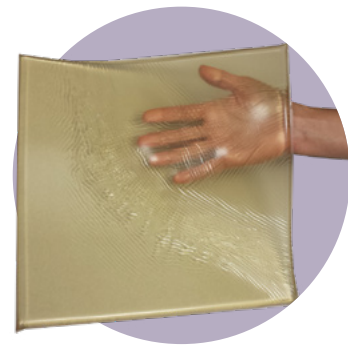

## Bolus

Bolus (Bolx® & Bolx II®) is made from a solid, tissue-equivalent gel. It will not sag, deform or run. Bolus is available “skinless”, or encased in a tough layer of thin plastic “skin”.

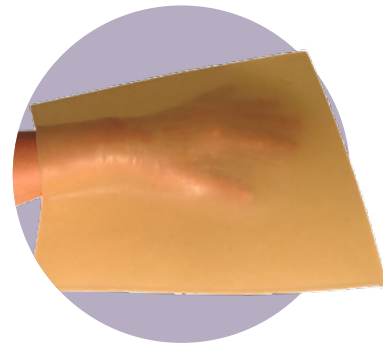

## Superflab Bolus

Tissue-equivalent bolus that is flexible and will not dry out. The slabs conform to the patient’s contour, while still maintaining uniformity in thickness. Superflab comes in different thicknesses to provide maximum dose buildup for relevant photon energies. Superflab Bolus is available in a wide variety of additional sizes. Not available in all markets.



## Unlimited Scissors

RT-4932

SIZE	THICKNESS	SKINLESS BOLUS	BOLUS W/ SKIN	SUPERFLAB BOLUS
30 x 30 cm	0.3 cm	-	31033030 / RT-31033030	RT-8117-3030-3
	0.5 cm	32052 / RT-32052	31052 / RT-31052	RT-8117-3030-5
	1.0 cm	32102 / RT-32102	31102 / RT-31102	RT-8117-3030-10
	1.5 cm	32152	31152 / RT-31152	
	2.0 cm	32202	31202 / RT-31202	
	3.0 cm	-	RT-31302	
30 x 50 cm	0.5 cm	-	31053050	
	1.0 cm	-	31103050	
15 x 15 cm	0.5 cm	-	31051 / RT-31051	
	1.0 cm	-	31101 / RT-31101	
	1.5 cm	-	31151	
40 x 40 cm	0.5 cm	-	31054040	
	1.0 cm	-	31104040	

# Bolus

visionrt | COMPATIBLE



## Aquaplast RT Custom Bolus & Adapt-It Thermoplastic Pellets

Used for hard-to-bolus areas such as: chest wall, nose, parotid, groin, ears, and any irregularly surfaced anatomical feature. The attenuation characteristics are comparable to other polymer-based products; however, its conformability to the anatomy is superior to other bolus products. Both products soften in hot water or RapidHeat Oven. It reduces setup time and minimizes air gaps and day-to-day variability. Bolus materials are available in a wide variety of additional sizes and thicknesses.

See Vision RT's compatibility statement on back cover.



RT-1910-4	Bolus, 4.8 mm, 200 mm x 230 mm
RT-1913-2	Bolus, 2.4 mm, 300 mm x 300 mm
RT-1913-3	Bolus, 3.2 mm, 300 mm x 300 mm
RT-1913-4	Bolus, 4.8 mm, 300 mm x 300 mm
RT-1922	Bolus, 4.8 mm, 450 mm x 600 mm
RT-1931-4	Bolus, 4.8 mm, 300 mm x 450 mm
RT-7001	Adapt-It Thermoplastic Pellets, 1 lb. bag
RT-7003	Adapt-It Thermoplastic Pellets, 3 lb. bag



## Pellet Bowl

Ideal for heating the desired amount of Aquaplast RT Pellets in either a hot air oven or water bath.

The compact and lightweight bowl can hold approximately ½ lb of pellets and can be fully expanded to 2” height or 0.5” when collapsed flat.

RT-2075-PB	Pellet Bowl (125 ml, 1/2 cup)
------------	-------------------------------

# Quality Assurance

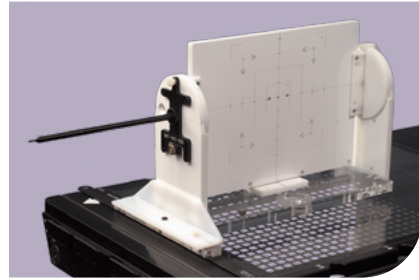

## Iso-Align™

The Iso-Align is a multi-purpose quality assurance device designed to assist in the routine secondary verification of linear accelerators and room lasers. The Iso-Align accommodates a convenient film pack for radiation and light field verification. The Iso-Point Rotational Runout Tool on the Iso-Align allows you to accurately and easily verify the mechanical isocenter of the gantry. In addition, the Iso-Align can be used to verify multiple aspects of linear accelerators and room lasers, including:

- Alignment of all lasers
- Collimator and table/couch rotational angle readout accuracy
- Light field alignment and jaw readout accuracy
- Mechanical isocenter of collimators and treatment tables/couches
- Optical Distance Indicator (ODI) accuracy at various distances
- Port film grid alignment
- Radiation and light field coincidence at various gantry angles
- Radiation isocenter of collimators, gantries, and treatment tables/couches

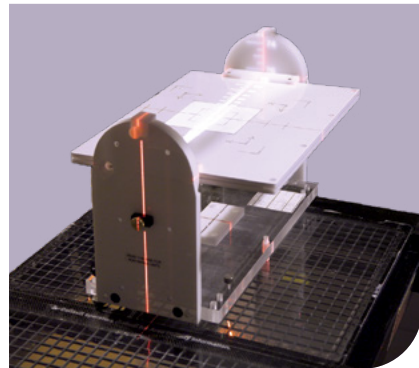

**MTIAD1**

## TG66 CT Simulation Laser QA Device

This unique device is used to complete secondary specific quality assurance checks of CT scanners and room lasers, in accordance with the recommendations of AAPM's TG66. Easily indexed to the CT table, this clearly-marked tool helps perform an array of important QA checks, including:

- Alignment of gantry lasers
- Spacing and orientation of room lasers
- Confirmation of a level and orthogonal table orientation

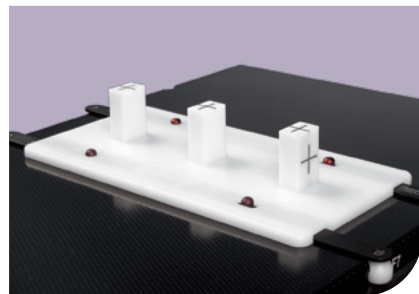

**MTTG66** Requires (Qty 2) Two-Pin Lok-Bar or Locating Bar

# Accessories & Aids

## Testicle Shields

Testicle Shields are designed to reduce scatter radiation to the testicles. Each unit is cast to provide a lead wall with a thickness of ½" (1.27 cm) and features an open sector to allow comfortable attachment to the patient. All surfaces are coated with a polyurethane paint.

The shield's top and bottom sections are secured with either the two included rubber straps or nylon tape. When using the testicle shield stand, no straps are needed.

**THESE PRODUCTS HAVE NOT BEEN CE MARKED**

<b>MTTSS</b>	Small, Qty 1
<b>MTTSM</b>	Medium, Qty 1
<b>MTTSL</b>	Large, Qty 1



## Testicle Shield Stand

This adjustable stand offers increased patient comfort while raising or lowering the shield. A manual adjustment knob allows for easy vertical positioning from 1-10" (2.54-25.4 cm). The stand can be used for anterior and posterior treatments.

**THIS PRODUCT HAS NOT BEEN CE MARKED**

**MTTSST2**



## Grip Rings™

Grip rings offer patients an extra measure of security and comfort. The tough blue vinyl is smooth and easy to wipe clean with most antibacterial solutions. Grip Rings are sold individually and in sets.

**THIS PRODUCT HAS NOT BEEN CE MARKED**

<b>MTVIP181 / RT-4487G-181</b>	Grip Ring Small (Children and Small Adults, 3" inside diameter)
<b>MTVIP182 / RT-4487G-182</b>	Grip Ring Medium (Average-Sized Adult Hands, 4.25" inside diameter)
<b>MTVIP183 / RT-4487G-183</b>	Grip Ring Large (Large Adult Hands and Adult Feet, 6" inside diameter)
<b>RT-4487G-083</b>	Grip Ring X-Large (Large Feet or Feet with Shoes)
<b>RT-4487G-084</b>	Grip Ring XX-Large (Extra Large Feet or Feet with Boots)
<b>MTVIP166 / RT-4487G-166</b>	Grip Ring Set of 3 (3, 4.25 and 6" inside diameter)
<b>MTVIP1664 / RT-4487G-166-4</b>	Grip Ring Set of 4 (3, 4.25, 6 and 8" inside diameter)



## Accessories & Aids

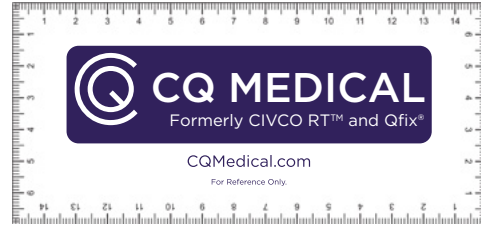

### Setup Rulers

Great aid to help with the setup of patients. These rulers start at "0" from the edge and the unit of measurement is millimeters. For reference only.

**CQRULER** Qty 1

### ALRA Skin Care

This special line of skin care products is designed to provide gentle, effective care for patients undergoing radiation therapy.

The moisturizer contains aloe vera, lanolin, Vitamin E, collagen and allantoin. It is fragrance-free. Unlike regular antiperspirants, the ALRA deodorant stick contains no metallic ingredients that can interfere with radiation. It contains the natural astringent cypress oil and the natural bactericide lichen. Patients can order ALRA products directly from us (North America only).

**THESE PRODUCTS HAVE NOT BEEN CE MARKED**

**MTCBALRASL4** Therapy Lotion, 4 oz

**MTCBALRAD** Non-Metallic Deodorant



### Table Strap

The Table Strap ensures patient control, safety and comfort with a strong material that feels soft to the touch. The Table Strap features a two-way adjustable fastener made of double-faced Velcro® brand loop. It can be washed and sterilized. Individually packaged.

4" wide x 72" long.

**THIS PRODUCT HAS NOT BEEN CE MARKED**

**MTVIP173**



## Accessories & Aids



### Incontinence Clamps

**THESE PRODUCTS HAVE NOT BEEN CE MARKED**

**MTVIPU414R** Cunningham Clamp, Regular

**MTVIPU414L** Cunningham Clamp, Large

**MTVIPU413** Zipser Clamp (right photo)



### Patient Transfer Board

The Patient Transfer Board is designed to ease patient transfer from a bed or stretcher to a treatment table with minimum effort. The board is constructed of a durable polyethylene material.

**THIS PRODUCT HAS NOT BEEN CE MARKED**

**MTVIP40**



### Calipers

Body Calipers can be used for tabletop distances to determine central-axis and off-axis measurements. The reversing caliper orientation assists in determining separations such as laterals, obliques and off-table measurements. The wide base ensures perpendicularity to tabletop. A color-coded scale on both sides eliminates confusion with scale orientation.

It is made of precision-machined aluminum with a gold-tone finish. Components are hand-tapped, counterbored and assembled with steel screws for strength and stability. The easy-to-read screen-printed scale is protected from wear by a recessed sliding scale indicator.

**THESE PRODUCTS HAVE NOT BEEN CE MARKED**

**MTBC45** Body Caliper, 45 cm

**MTBC55** Body Caliper, 55 cm



# Storage Solutions



## Wall Mount

Designed to store your Alta, QUANTUM CT Overlay, DoseMax, Low-e, Access Supine Breast Device, AccuFix Head & Neck Device, and Portrait Intracranial, Head & Neck Device.

RT-4543WALL



Wall Mount shown with compatible devices



## Overlay Stand

The Overlay Stand is ideal for shared CT rooms, where space is limited. The Overlay Stand creates a fast and effective way to store and protect your CT overlay between uses. The base and strap plate easily mount to the wall, allowing for quick access and out-of-the-way storage. Upper straps secure the overlay between uses.

MTIL1104

## Universal Couchtop Long Extension Storage Device

MTIL6000SU For up to four long extensions

MTIL6100SU For one long extension (included in UCT LE package)



# Storage Solutions



## Combifix Wall Storage

O13115 not for use in MR environment



## Bellyboard Wall Storage

Compatible with the Carbon Fiber Bellyboard and MRSeries Bellyboard

O13140



## Head, Neck & Shoulders Baseplate Storage

Two-Pin Baseplate Storage, compatible with two-pin Posifix and Posirest baseplates and most other two-pin ready baseplates

O13159



## C-Qual Breastboard Wall Storage Device

A convenient wall-mounted rack is available for C-Qual M and C-Qual breastboard storage.

O13156



## ONEBridge Storage Base

Holds the ONEBridge in an upright position. Designed to sit on a countertop or cart.

BPL005



## Body Pro-Lok Bridge Storage

Two storage options, a cart, and a wall mounted unit are available.

MTSBRT203 Cart

MTSBRT224 Wall Unit

# Storage Solutions



## Vac-Lok Storage Rack

This space saving rack holds molded & inflated cushions. Plastic "S" hooks are available for hanging cushions.

<b>MTVL401</b>	Storage Rack, Double Wide
<b>MTVL402</b>	Casters for MTVL401, Qty 4
<b>MTVLHOOK</b>	"S" Hooks, Qty 10



## Storage Cart

Great option for storing kVue inserts, Encompass, Portrait, BoS, Access 360, DoseMax, and Low-e inserts.

<b>RT-4552CART</b>	Storage Cart has four sections to hold multiple devices
--------------------	---



## Water Bath Cart

The Water Bath Cart provides an easy, efficient way to transfer a water bath or Rapid Heat Oven between treatment rooms. Load capacity of 500 lbs (227 kg).

Dimensions: (W x D x H - height includes handles)

Overall: 25.5 x 43 x 38" (64.8 x 109.2 x 96.5 cm)

<b>MTMC01003</b>	
------------------	--



## Mobile Accessory Cart

This accessory cart has been specially designed to hold a wide variety of patient positioning and fixation devices. The cart can hold up to 300 lbs (135 kg) and measures 40<sup>5</sup>/<sub>8</sub> x 20 x 37<sup>13</sup>/<sub>16</sub>" (103.2 x 50.8 x 96 cm). An optional storage bin is available for storing smaller items.

<b>MTMC020</b>	Mobile Accessory Cart
<b>20MC02005</b>	Storage Bin

## A

- ABS Reloadable Type-S Frame Only **80**
- Accessory Ladder Set **128**
- Access Prone G2 Breast Device **133,134**
- Access Supine **125**
- AccuForm Cushions **107,195,197**
- Accusyte **171**
- Acrylic Supine Baseplate Posifix **95**
- Uni-frame **90**
- Adapters **113,114**
- AirShuttle & AirDrive **29**
- Align Markers **169**
- ALRA Skin Care **210**
- Alta AirShuttle **32**
- Alta for Pelvis **142**
- Alta for SBRT **51**
- Alta Multipurpose Device **36,37**
- Aquaplast RT **74**
- Aquaplast RT Aqua-Brief **142**
- ArmShuttle Elite **126**
- Arm Supports
  - Arm & Wrist Supports **126**
  - Monarch Overhead Arm Positioner **123**
  - Wing Boards **136**

## B

- Bellyboards
  - Carbon Fiber **145**
  - MRSeries **145**
  - SofTouch Elite **146**
  - Storage **213**
- Body Calipers **211**
- Body Pro-Lok ONE **45,46,47**
- Storage **213**
- Body Pro-Lok ONE evo Adapter **46,48**
- Bolus **206**
- Bone Markers **169**
- BoS AirShuttle **33**
- BoS Thermoplastics **200,201**
- Breastboards
  - Access Prone G2 Breast Device **133**
  - Access Supine & Access Supine MR **125**
  - C-Qual **124**
  - C-Qual M **122**
  - Evolve **129**
  - kVue Access 360 G2 Prone Breast Insert **131**
  - New Horizon Prone **135**
  - Thorawedge **137**
- Breast Support Thermoplastic **122**
- Breast & Thorax Vac-Lok Cushions **154**

## C

- Calipers **211**
- Carbon Fiber Bellyboard **145**
- Carbon Fiber Supine Baseplate Posifix **95,213**
- Uni-frame **90**

- Chamfered AccuForm **107**
- Chin Strap Thermoplastic **98**
- Clam-Lok Cushion **48**
- ClearVision 2 **194,196**
- ClearVision Thermoplastic **85,92**
- Combifix 3 **145**
- Comfort Marker 2.0 **173**
- Couchtops **10,11,12,13,25**
- Couchtop Service Panel **24**
- Couchtops & Overlays **7**
- Coupled Markers **168**
- C-Qual Breastboard **124**
- C-Qual M Breastboard **122**
- C-Qual Wall Storage Device **213**
- CT Overlays **19**
- Customizable Head Support **104**
- CyberMark Markers **169**

## D

- DecoColor Markers **179**
- Direct Indexing Adapters **113**
- Disposable Rectal Markers **178**
- Disposable Vaginal Markers **178**
- Dual Leg Positioner **149**

## E

- Elekta Unity Lok-Bar **181**
- Elevation Blocks **49**
- Encompass SRS Immobilization System **60,61,62,67**
- End Plate for Varian **25**
- evo Adapter **48**
- Evolve Breastboard **129**
- Exact Lok-Bar **21**
- Extended Head Stop Headrests **110**
- Extended Wing Board **136**

## F

- Feetfix 3 **49,148**
- Fibreplast **74**
- Fiducial Markers
  - Accusyte **171**
  - Align Markers **169**
  - Bone Markers **169**
  - Coupled Markers **168**
  - CyberMark Markers **169**
  - FlexiCoil Markers **168**
  - FlexiMarc G/T Markers **168**
  - FusionCoil Markers **166**
  - Gold Soft Tissue Markers **170**
  - PointCoil Markers **167**
  - PolyMark Markers **167**
  - Suture-Type Markers **169**
- Fixator **80**
- FlexiCoil Markers **168**
- FlexiMarc G/T Markers **168**
- FlexLock Knee & Foot Supports **144**
- Foam Positioners **164**
- Foot Extension **25**
- Forehead Restraint **48**

- FreedomView Reinforced Style 18 **194,196**
- FusionCoil Markers **166**

## G

- Gold Soft Tissue Markers **170**
- GrayDuck Stents **106**
- Grid Long Extension **11**
- Grip Rings **209**

## H

- Headboards **89**
- Head, Neck & Shoulders Baseplates **95,213**
- Head & Neck Vac-Lok Cushions **155**
- Head-Only Baseplates **95**
- Headrests
  - AccuForm **107**
  - Adapters **113,114**
  - Customizable Head Support **104**
  - Extended Head Stop Headrests **110**
  - Posifix Contoured Headrests **111**
  - Posifix Pediatric Headrests **111**
  - Posifix Prone Headrest **111**
  - Posifix Supine Headrests **110**
  - Posifix Wide Headrest **111**
  - Prone Head Cushion & Adapter **112**
  - Silverman Headrests **109**
  - Silverman Headrests (Low Profile) **109**
  - Timo Headrests **110**
- Helping Hands **160**
- HipFix Immobilization System **140**
- Thermoplastics **141**
- Hip & Pelvic Vac-Lok Cushions **155**

## I

- iBEAM Overlay Adapter **80,95**
- I.D. Tags **160**
- IMRT Reinforced Thermoplastics
  - Breast Support **122**
  - HipFix **141**
  - ThermFix **143**
- Incontinence Clamps **211**
- Individual Head Support **108**
- InfinityLock Bridges & Paddle **52**
- InkAlign **174**
- INSIGHT **184**
- IntegraBite **105**
- Integrated Shim **81**
- Integrated Shim Thermoplastics **82**
- Interloc Lok-Bar **21**
- Iso-Align **208**

## K

- Kneefix 3 **49,148**
- kVue Access 360 G2 Prone Breast Insert **17,131,132**
- kVue BoS Proton System **199**
- kVue Couchtop **13**
- kVue CT Overlay **13**

# Index

kVue Insert Docking Plate **24**  
kVue Inserts **15,16,18,55**  
kVue One Couchtop **14**  
kVue One Proton Couchtop **198**  
kVue Portrait Proton System **203**  
kVue Proton Couchtop **198**  
kVue Virtual Indexing **18**

## L

Lateral Baseplate **90**  
Leg Roll Positioner **163**  
Lithotomy AirShuttle **30,31**  
Locating Bars **23**  
Lok-Bars **21,22,50,161**  
Long Extension Storage Device **212**  
L-Profile Thermoplastics **99**

## M

M.C. Inspire Baseplate **103**  
Miscellaneous Thermoplastics **88,93**  
Mobile Accessory Cart **214**  
Monarch Overhead Arm Positioner **49,123**  
Monarch Thermoplastic Frame **123,124**  
MRI Overlays **181,183**  
MRI Type-S Overlay **80**  
MR Posi-S Adapter **79**  
MRSeries Bellyboard **145**  
MRSeries Positioning **186,187,188**  
Multi Purpose Support Cushions **163**

## N

New Horizon Prone Breastboard **135**  
Non-Metallic Deodorant **210**

## O

ONEBridge **45,48**  
ONEBridge Storage Base **213**  
ONEPlatform **46,49**  
ONE Respiratory Belt **48**  
Overlay Board **80**  
Overlays - CT **20**  
Overlays - MR **181,183**

## P

Patient Handles **25,50**  
Patient Marking  
  Comfort Marker 2.0 **173**  
  DecoColor Markers **179**  
  InkAlign **174**  
  Portal Markers **179**  
  Rectal Markers **178**  
  Rulers **179**  
  Sharpie Markers **179**  
  Suremark Markers **175-178**  
  Vaginal Markers **178**

Patient Transfer Board **211**  
Pediatric Masks **87,196,197**  
Pediatric ProForm Thermoplastics **101,196,197**  
Pelvis Thermoplastics **141,143**  
PointCoil Markers **167**  
PolyMark Markers **167**  
Portal Markers **179**

Portrait Head & Shoulder Thermoplastic  
  Adapters **127**

Portrait with Integrated Shim **81**  
Posicast-Lite and Posicast-Plus  
  Thermoplastics **97**

Posicast-Lite & Posicast-Plus **74**  
Posicast-Lite Thermoplastics **97**

Posicast Microperfo Plate **98**  
Posifix Contoured Headrests **111**

Posifix Long Extension **12**  
Posifix Pediatric Headrests **111**

Posifix Prone Headrest **111**  
Posifix Supine Headrests **110**

Posifix System  
  Baseplates **95,96,97**

  Extensions **94**  
  Posicast Thermoplastics **101,196,197**

  Posifix Variable Axis Baseplate **95**  
Posifix Thermoplastics **96-98**

Posifix Wide Headrest **111**  
Precise Bite **105**

Prodigy 2 Lok-Bar **21,50**  
Prodigy Lok-Bar **21**

ProForm **193**  
  Pediatric Extension & Overlays **100**

  Thermoplastic **194-197**

Prone CSA Kit **89**  
Prone Head Holder **90**

Prone-Lok Cushion **147**  
Prone Thorax Support **147**

Prone VacQfix Indexer **161**  
Pron-Pillo Cushion **147**

Pro Wing Board **130**

## Q

Quality Assurance **208**  
QUANTUM CT Overlays **19**

## R

Rapid Heat Oven **114**  
RectalPro 75 Endorectal Balloon (ERB) **150**

Rectal & Vaginal Markers **178**  
Rectangular Long Extension **11**

RediFoam **163**  
Registration Film **195,197**

Reinforced Style 18 **195,197**  
Reinforced Style 18 with Hair Openings **195**

Reinforcement Thermoplastic Strips **88,93**

Respiratory Belt **45**  
Respiratory Plate **45**

Respiratory Plate, Standard **48**

Respiratory Plate, Wide **48**

Rulers **179,210**

## S

SBRT Body Pro-Lok ONE **46,47**

SBRT Customization **48,49,50,53,54**

SBRT ONEPlatform Packages **46**

Sharpie Markers **179**

Shims **109**

Shoulder Retractor **108,112**

Shoulder Support Cushion **163**

Shoulder Thermoplastic **65,85,98**

Silverman Adapter for Breast Devices &  
  ArmShuttle **128**

Silverman Headrests **109**

Skinless Bolus **206**

Slate AirShuttle **33**

Slide Guide Lok-Bar **22,50**

SofTouch Couchtop Pads **24**

SofTouch Elite Bellyboard **146**

Soft Tissue Gold Markers **170**

Solid With Perforated Nose **195**

Solstat Immobilization System **102**

Solstice SRS Immobilization System **63,64,65**

Spacers **112**

Spacers & Wedges **112**

Split-Leg Vac-Lok **140**

SRS Adapter **66**

SRS Headrests **67**

Standard Perforated **195,197**

Standard Perforation Thermoplastics  
  Breast **122**

  HipFix **141**

Standard Respiratory Plate **48**

Standard Wing Board **136**

Storage Solutions **212-214**

Suremark Markers **175-178**

Suture-Type Markers **169**

Symphony Patient Transfer System **28**

## T

Table Strap **210**

Tapered Wing Board **136**

Testicle Shields **209**

Testicle Shield Stand **209**

TG66 CT Simulation Laser QA Device **208**

Therapy Lotion **210**

ThermFix Immobilization System **140**

  Thermoplastics **141**

Thermoplastic Breast Adapter **127**

# Index

Thermoplastic Chin Strap **127**  
Thermoplastics

  L-Profile Thermoplastics **99**  
  Pediatric ProForm **101,196-197**

  Posifix Thermoplastics **96-98**

  ProForm Thermoplastic **194-197**

  Type-S Thermoplastics **82-88**

  Uni-frame Thermoplastics **91-93**

  Thorawedge **137**

  Three-Pin Lok-Bar **22,181**

  Tilt-Pro Tilting Base **89**

  Timo Headrests **110**

  TotalRT All in One Platform **39,40**

  Transverse Lok-Bar **22,50**

  T-Shape Vac-Lok **49,153**

  Type-S Long Extension **12**

  Type-S System  
    Baseplates **79**

    Extensions **77**

    Fixator **80**

    iBEAM Overlay Adapter **80**

    MRI Type-S Overlay **80**

    Overlay Board **80**

    Overlays **79,80**

    Platforms **78**

    Standard Perforation **87**

    Thermoplastics **82-88**

    Universal Couchtop Long Extension **77**

    Variable Axis Baseplate **79**

    Varian Style Extension **77**

  Type-S Thermoplastics **82-88**

## U

Uni-frame System  
  Baseplates **89,90**

  Lateral Baseplate **90**

  Prone Head Holder **90**

  Thermoplastics **91,93**

  Tilting Baseplates **90**

Uni-frame Thermoplastics **91-93**

Universal Couchtop 1 Piece **10**

Universal Couchtop Accessories **25**

Universal Couchtop Head Extension **25**

Universal Couchtop Long Extension **10,11,12,25**

Universal Couchtop SBRT Packages **46**

## V

Vac-Lok Cleaner **160**

Vac-Lok Cushions

  Breast & Thorax **154**

  Head & Neck **155**

  Helping Hands **160**

  Hip & Pelvic **155**

  Non-Rectangular **153**

  Rectangular **152**

  Storage Racks **160,214**

Vac-Lok Storage Racks **214**

VacQfix Cushions **156,157,158,159**

VacQfix Indexer **161**

Vacuum Compressors **162**

Vaginal Markers **178**

Variable Axis Baseplate **79,95**

Varian Style Extension **77,94**

Virtual Indexing **18**

## W

Water Bath Cart **115**

Water Baths **115**

Wedges **112**

Wide Respiratory Plate **48**

Wide Respiratory Plate with ComfortCare  
  Cushion **45**

Wing Boards **136**

  ArmShuttle Elite **126**

  Monarch Overhead Arm Positioner **123**

  Pro Wing Board **130**

## Z

ZENTEC Thermoplastics **74,86**

ZiFix Traverse **52**



# Part Number Index

20CFHNPSUBIP 87  
 20CFHNPSUBIP 80  
 20CFHNSUB2 80  
 20CFHNSUB7 80  
 20MC02005 214  
 20VARSUB10 21  
 013115 213  
 013140 145,213  
 013156 213  
 013159 95,213  
 31051 206  
 31052 206  
 31101 206  
 31102 206  
 31151 206  
 31152 206  
 31202 206  
 32052 206  
 32102 206  
 32152 206  
 32202 206  
 101019 95  
 102021 95  
 104021 95  
 105021 95  
 107063 149  
 107065 95  
 107101 112  
 107102 112  
 107103 112  
 107104 112  
 107106 112  
 108010 94  
 108020 94  
 108072 95  
 108073 80  
 125012 145  
 126000 145  
 151004MR 145  
 151005MR 145  
 301008A 111  
 301022 111  
 301023 111  
 301024 111  
 301025BLK 79,111  
 301026 111  
 301027A 111  
 301029 114  
 301030 110  
 301032 110  
 301033 110  
 301034 110  
 301035 79,114  
 301040 163  
 301048 148  
 301052 49,148  
 301055 49,148  
 301056 148  
 301071 49,148  
 301076 147  
 301080 137  
 301081 137  
 301082 137  
 301102 147  
 301201 110  
 301202 110  
 301203 110  
 301204 110  
 301205 110  
 301234 111  
 302071MR 145  
 302072 145  
 305001 110  
 400006 163  
 402422 163  
 402525 163  
 402820 163  
 402848 163  
 403024 163  
 772021 98,123  
 772030 97  
 772044 97  
 772145 97  
 924392 98  
 930030 97  
 930033 97  
 930044 97  
 930055 97  
 930080 149  
 930145 97  
 970031 97,123  
 8003020 126  
 31033030 206  
 31053050 206  
 31054040 206  
 31103050 206  
 31104040 206  
 BPL001 48  
 BPL003 49  
 BPL005 213  
 BPL007 48  
 BPL008 48  
 BPL009 48  
 BPL010 48  
 BPL020 47  
 BPL026 48  
 BPL100 46  
 BPL110 46  
 BPL120 48  
 BPL150 46  
 BPL200 46  
 BPL210 46  
 BPL230 46  
 BPL300 47  
 BPLONEUPG3 46  
 CHS01 104  
 CHS02 104  
 CHS03 65,102  
 CHS03K 64  
 CHS03MR 65  
 CHS03MRK 64  
 CHS03MRSGK 64  
 CHS03SGK 64  
 CHS04 65,102

CHS04K 64  
 CHS04MR 65  
 CHS04MRK 64  
 CHS04MRSGK 64  
 CHS04SGK 64  
 CHS05 102  
 CHS06 102  
 CHS14SGK 103  
 CHS18MRSGK 103  
 CHS40 102  
 CHS40K 102  
 CHS41 102  
 CHS42 102  
 CQRULER 179,210  
 GDS001 106  
 GDS002 106  
 GDS003 106  
 MPCM2010 173  
 MPCM2010INT 173  
 MPCM4022 173  
 MPCM4022INT 173  
 MT202 90  
 MT400 124  
 MT401 124  
 MT20100 90  
 MT20100CF 90  
 MT20103CF 90  
 MT20104 90  
 MT20108 90  
 MTAACL001 107  
 MTAACL1520 107  
 MTAACL2035  
 65,102,104,107,195,197  
 MTAACL2035HF 65,102,104,107  
 MTAACL2035U 107  
 MTAACL2045 107  
 MTAACL4060 107  
 MTAACL5865T 107  
 MTAACL6060 107  
 MTAACL14242 107  
 MTAACLSHIM 107  
 MTAACLTYPES1 107  
 MTAPCID1832 65,102  
 MTAPCID1832SG 61,65,102  
 MTAPCIN1832 65,102  
 MTAPCIN1832SG 65,102  
 MTAPS3.2 88  
 MTAPS25 88,93  
 MTAPS35 88,93  
 MTAPS18391 88,93  
 MTAPSD001 88  
 MTAPSD2.4 87  
 MTAPSD3.2 87  
 MTAPSID27NR24 86  
 MTAPSID27NR32 86  
 MTAPSID29NR24 88  
 MTAPSID29NR32 88  
 MTAPSID2724 86  
 MTAPSID2724VT 86  
 MTAPSID2732 86  
 MTAPSID2732SG 85  
 MTAPSID2732VT 86  
 MTAPSID2924 88  
 MTAPSID2932 88  
 MTAPSP2.4 87  
 MTAPSPSF 65,85,98  
 MTAPSSTS 65,85,102  
 MTAPU 93  
 MTAPU1.6 93  
 MTAPU2.4 93  
 MTAPU12 93  
 MTAPU14 93  
 MTAPU122.4 93  
 MTAPU142.4 93  
 MTAPUD 87  
 MTAPUD002 88  
 MTAPUD2.4 87  
 MTAPUD1224 88  
 MTAPUD1424 88  
 MTAPUI1824 92  
 MTAPUI1824VT 92  
 MTAPUI1832 92  
 MTAPUI1832CL 92  
 MTAPUID1824 86  
 MTAPUID1824VT 86  
 MTAPUID1832 86  
 MTAPUID1832SG 85  
 MTAPUID1832VT 86  
 MTAPUID2024 88  
 MTAPUID2032 88  
 MTAPUID2232 88  
 MTAPUID181232 88  
 MTAPUID181332RD 86  
 MTAPUID181432 88  
 MTAPUIR1832 88  
 MTAPUIR1832CL 92  
 MTAPUIR2032 88  
 MTAPUIW1824VT 92  
 MTAPUIW1832VT 92  
 MTAPUL 90  
 MTAPUL2.4 90  
 MTAPUR 88  
 MTAPUR2.4 88  
 MTAPUR122.4 88  
 MTAPUW 93  
 MTAPUW2.4 93  
 MTAPUW122.4 93  
 MTBC45 211  
 MTBC55 211  
 MTCB36 147  
 MTCBALRAD 210  
 MTCBALRASL4 210  
 MTCBPBITE 105  
 MTCBPBITES 102,105  
 MTCBPBITETD 105  
 MTCBPBITETDS 105  
 MTCBPBITEWRM 105,115  
 MTCBPFC 160  
 MTCBPLL 115  
 MTCFHNO06 80  
 MTCFHNO06SUB6 80  
 MTCFHN 77  
 MTCFHNAB01 79  
 MTCT23 176

# Part Number Index

MTCT40 176  
 MTCTCR3 176  
 MTCTW10 176  
 MTCTW20 176  
 MTCTXFC001 166  
 MTCTXFC105185 166  
 MTCTXFC1051820 166  
 MTCTXFC1051825 166  
 MTCTXFC09101820 168  
 MTCTXFC10201820 166  
 MTCTXFC10251820 166  
 MTCTXFC12101720 168  
 MTCTXFC12201720 168  
 MTCTXGT10182010 168  
 MTCTXGT10182020 168  
 MTCTXPC0605 167  
 MTCTXPC08185 167  
 MTCTXPC0819153 167  
 MTCTXPM0834 167  
 MTCTXPM101820 167  
 MTCTXPM101825 167  
 MTDL12 149  
 MTDLIZ2 149  
 MTFA39B 163  
 MTFA40B 163  
 MTFA41B 163  
 MTGBSUB1 136  
 MTGBSUB3 136  
 MTHF1822 141  
 MTHF18222.4 141  
 MTHFX1822 141  
 MTHFX1822S 141  
 MTHFX18222.4 141  
 MTHFX18222.4S 141  
 MTHPB01 135  
 MTHPB01K 135  
 MTHPB103 135  
 MTIAD1 208  
 MTHS01 108  
 MTHS02 108  
 MTIL1006 22,161  
 MTIL1104 212  
 MTIL3013 20  
 MTIL3019 20  
 MTIL3020 20  
 MTIL3051 21  
 MTIL3151 20,21  
 MTIL3152 20,22  
 MTIL3300 20  
 MTIL3310 20  
 MTIL3311 20  
 MTIL3350 21  
 MTIL3351 22,181  
 MTIL3352 22,181  
 MTIL3404 20  
 MTIL3454 22,181,183  
 MTIL3455 183  
 MTIL3651 21  
 MTIL3652 22  
 MTIL3653 20,21  
 MTIL3704 20  
 MTIL3705 20  
 MTIL3850 21  
 MTIL3950 22  
 MTIL4101 20  
 MTIL6000SU 212  
 MTIL6020 10  
 MTIL6022 10  
 MTIL6023 10  
 MTIL6024 10  
 MTIL6026 10  
 MTIL6027 10  
 MTIL6028 10  
 MTIL6029 10  
 MTIL6040 10  
 MTIL6042 10  
 MTIL6044 10  
 MTIL6045 10  
 MTIL6046 10  
 MTIL6047 10  
 MTIL6048 10  
 MTIL6049 10  
 MTIL6050 21,50  
 MTIL6051 21,22,50  
 MTIL6053 21  
 MTIL6054 21,22,50,181  
 MTIL6058 22  
 MTIL6100SU 212  
 MTIL6120 10  
 MTIL6121 10  
 MTIL6140 10  
 MTIL6141 10  
 MTIL6142 10  
 MTIL6152 25  
 MTIL6220 10  
 MTIL6240 10  
 MTIL6320 10  
 MTIL6321 10  
 MTIL6322 10  
 MTIL6323 10  
 MTIL6341 10  
 MTIL6342 10  
 MTIL6343 10  
 MTIL6420 10  
 MTIL6440 10  
 MTIL6520 10  
 MTIL6521 10  
 MTIL6540 10  
 MTIL6541 10  
 MTIL6612 25  
 MTIL6617 25  
 MTIL6660 11,192  
 MTIL6661 11  
 MTIL6663 11  
 MTIL6664 12,77  
 MTIL6665 12,77  
 MTIL6666 12,94  
 MTIL6667 25  
 MTIL6668 12,94  
 MTIL6669 11  
 MTIL6670 12,77  
 MTIL6671 12,94  
 MTIL6672 12,94  
 MTIL6673 11,192

MTIL6675K 12,193  
 MTIL6676 11,192  
 MTIL6682K 12,193  
 MTIL6683K 193  
 MTIL6684 192  
 MTIL6840 192  
 MTIL6841 192  
 MTIL7040 192  
 MTIL662501 25,50  
 MTIL662502 25,50  
 MTIL3006002 25  
 MTLTBP 90  
 MTLTBP2 90  
 MTLTBPIAT01 90  
 MTM400 122  
 MTM500 130  
 MTM3000 183  
 MTM3001 183  
 MTM3002 183  
 MTM3003 183  
 MTM3004 181  
 MTM3302 183  
 MTM3304 181  
 MTM3401 183  
 MTM3404 183  
 MTMCO20 214  
 MTMCO1003 115  
 MTMRHNP 80  
 MTMRHNTYPES 80  
 MTNW887709 168  
 MTNW887710 168  
 MTNW887711 168  
 MTNW887712 168  
 MTNW887805 169  
 MTNW887808 170  
 MTNW887809 170  
 MTNW887812 170  
 MTNW887825 170  
 MTNW887830 170  
 MTNW887835 170  
 MTNW887836 170  
 MTNW887837 170  
 MTNW887840 170  
 MTNW887851 169  
 MTNW887853 169  
 MTNW887855 169  
 MTNW887860 170  
 MTNW887866 169  
 MTNW887870 170  
 MTNW887871 170  
 MTNW887872 170  
 MTNW887873 170  
 MTNW887881 169  
 MTNW887882 169  
 MTNW887883 169  
 MTPFCO2 79  
 MTPLC01 147  
 MTPLHA01 141  
 MTPLHA0201 141  
 MTPLHA0202 141  
 MTPLHA10203 141  
 MTPLVCO4MR 140  
 MTPM100 179  
 MTPM150 179  
 MTRFH3 122  
 MTRF1918 122  
 MTRF19182.4 122  
 MTRFX918 122  
 MTRFX9182.4 122  
 MTRH1500 115  
 MTRH1500EX 115  
 MTSBRT003 48  
 MTSBRT018 48  
 MTSBRT202 48  
 MTSBRT203 213  
 MTSBRT224 213  
 MTSHIM01 109  
 MTSHIM01S 109  
 MTSHIMS 109  
 MTSHIMT 79,109  
 MTSILVER2 109  
 MTSILVER2A 109  
 MTSILVER2B 109  
 MTSILVER2C 109  
 MTSILVER2E 109  
 MTSILVER2F 109  
 MTSL10 175  
 MTSL15 175  
 MTSL15T 175  
 MTSL20 175  
 MTSL20T 175  
 MTSL25 175  
 MTSL25RT 177  
 MTSL30 175  
 MTSL40 175  
 MTSLCL20 177  
 MTSLCL25 177  
 MTSLLM1 178  
 MTSLLM2 178  
 MTSLV25 176  
 MTSLV30 176  
 MTSLV40 176  
 MTSLV50 176  
 MTSW3 175  
 MTSW4 175  
 MTSW8 175  
 MTSW12 175  
 MTSW15 175  
 MTSR01 108  
 MTSR02 108  
 MTSR03 108  
 MTSRP104 171  
 MTTG66 208  
 MTTIMO 110  
 MTTIMOA 110  
 MTTIMOB 110  
 MTTIMOC 110  
 MTTIMOD 110  
 MTTIMOE 110  
 MTTIMOF 110  
 MTTIMOL 110  
 MTTSL 209

# Part Number Index

MTTSM 209  
MTTSS 209  
MTTSST2 209  
MTULB001 22,181  
MTULB002 181  
MTVAR46 22  
MTVIP40 211  
MTVIP166 209  
MTVIP173 210  
MTVIP181 209  
MTVIP182 209  
MTVIP183 209  
MTVIP1664 209  
MTVIPFFF101C 164  
MTVIPFFF102C 164  
MTVIPFFF103C 164  
MTVIPFFF104C 164  
MTVIPFFF105C 164  
MTVIPFFF106C 164  
MTVIPFFF203C 164  
MTVIPFFF205C 164  
MTVIPFFF301C 164  
MTVIPFFF302C 164  
MTVIPFFF303C 164  
MTVIPFFF309C 164  
MTVIPFFF401C 164  
MTVIPFFF402C 164  
MTVIPFFF405C 164  
MTVIPFFF407C 164  
MTVIPFFF502C 164  
MTVIPFFF704C 164  
MTVIPFFF801C 164  
MTVIPFFF802C 164  
MTVIPFFF803C 164  
MTVIPFFF804C 164  
MTVIPFFF805C 164  
MTVIPU413 211  
MTVIPU414L 211  
MTVIPU414R 211  
MTVL71FC 140  
MTVLHH150 160  
MTVLHOOK 160,214  
MTVLTAG 160  
MTVPI 162  
MTVPEXA 162  
MTVPEXC 162  
MTVPEXD 162  
MTVPEXG 162  
MTVPEXH 162  
MTVPFT 162  
MTVRT20 85  
MTVRTW 92  
MTWBO8T 136  
MTWBO8U 136  
MTWBO9 136  
MTWB10T 136  
MTWB10U 136  
MTZM1710 178  
MTZM1735 178  
MTZM1740 178  
OAPI00 124  
OAPI10 49,123  
OAPI20 123,124  
OAPI40 130  
OAPI60 123  
OAPI70 123  
OAPI80 123  
OAP200 130  
OAP221 123  
OAP223 130  
OAP224 130  
OAP240 130  
OAP300 130  
PRO300K 193  
PRO320K 193  
PRO330 195  
PRO330IM1832 195  
PRO330IM1832CL 194  
PRO330IM1832PT 195  
PRO330IM1832SG 194  
PRO330SPN32 195  
PRO331IM1832 195  
PRO331IM1832CL 194  
PRO331IM1832CLN 194  
PRO331IM1832N 195  
PRO331IM1832S 194  
PRO340 195  
PRO400K 193  
PRO420K 193  
PRO430 197  
PRO430IM1832 101,197  
PRO430IM1832CL 101,196  
PRO430IM1832SG 101,196  
PRO431IM1832 101,197  
PRO431IM1832CL 101,196  
PRO431IM1832SG 101,196  
PRO440 101,197  
PRO450 101,197  
PRO3311832SGN 194  
RT-1500-04 202  
RT-1776KSDGXF 83  
RT-1776KSDGXF 83  
RT-1778KFORF3 99  
RT-1778KFORF5 99  
RT-1778KORF5 99  
RT-1778KPR3D 96  
RT-1778KPR3DF 96  
RT-1778KPR5D 96  
RT-1778KPR5DF 96  
RT-1778KSDF 84  
RT-1778ORF3 99  
RT-1778ORF4 99  
RT-1778ORF5 99  
RT-1778PR2DC 127  
RT-1778PR3 96  
RT-1778PR3D 96  
RT-1778PR5 96  
RT-1778PR5D 96  
RT-1779 91  
RT-1779KS 91  
RT-1779KSD 83  
RT-1779KSL 91  
RT-1779L 91  
RT-1779S 91

RT-1779SD 83  
RT-1779SDL 83  
RT-1779SL 91  
RT-1782BOS-DXS 200  
RT-1782KORF5 99  
RT-1782KPR3D 96  
RT-1782KPR5D 96  
RT-1782KSD 84  
RT-1782KYSDF 84  
RT-1782ORF3 99  
RT-1782ORF4 99  
RT-1782ORF5 99  
RT-1782PR3 96  
RT-1782PR3D 96  
RT-1782PR4 96  
RT-1782PR5 96  
RT-1782PR5D 96  
RT-1782SD 84  
RT-1783P3 127,143  
RT-1821KP 141  
RT-1821P 141  
RT-1822P18A 143  
RT-1823P12A 143  
RT-1848 143  
RT-1876KFORF3 99  
RT-1876KFORF5 99  
RT-1876KSDGLF 83  
RT-1876KYSDF 83  
RT-1878BOS-D2L 201  
RT-1878BOS-D2LS 201  
RT-1878BOS-D2LVS 200  
RT-1878BOS-E2L 201  
RT-1878BOS-E2LS 201  
RT-1878KBOS-D2L 201  
RT-1878KBOS-D2LS 201  
RT-1878KBOS-D2LSF 200  
RT-1878KBOS-D2LVS 200  
RT-1878KBOS-E2L 201  
RT-1878KBOS-E2LF 200  
RT-1878KBOS-E2LS 201  
RT-1878KSDF 84  
RT-1882BOS-D 201  
RT-1882BOS-DS 201  
RT-1882BOS-DVS 200  
RT-1882BOS-E 201  
RT-1882BOS-ES 201  
RT-1882KBOS-D 201  
RT-1882KBOS-DVS 200  
RT-1882KBOS-DXS 200  
RT-1882KBOS-E 201  
RT-1882KBOS-ES 201  
RT-1882KP 141  
RT-1882ORF3 99  
RT-1882ORFPLV4 143  
RT-1882P 141  
RT-1882P18A 143  
RT-1883P12A 143  
RT-1889 91  
RT-1889KS 91  
RT-1889KSD 83  
RT-1889KSDL 83  
RT-1889KSD-S3 83

RT-1889KSL 91  
RT-1889KS-S3 92  
RT-1889KYFORF3 99  
RT-1889KYFORF5 99  
RT-1889KYS 91  
RT-1889KYS 83  
RT-1889KYSGLF 92  
RT-1889L 91  
RT-1889S 91  
RT-1889SD 83  
RT-1889SDL 83  
RT-1889SD-S3 83  
RT-1889SL 91  
RT-1889S-S3 92  
RT-1889YS 91  
RT-1889YSD 83  
RT-1889YSDR 83  
RT-1889YSR 91  
RT-1892KSD 84  
RT-1892KYSDF 84  
RT-1892SD 84  
RT-1892YSD 84  
RT-1892YSDR 84  
RT-1910-4 207  
RT-1913-2 207  
RT-1913-3 207  
RT-1913-4 207  
RT-1922 207  
RT-1931-4 207  
RT-1969 89  
RT-1989S 91  
RT-2075-110 114  
RT-2075-220 114  
RT-2075-PB 207  
RT-4415RP-50 150  
RT-4420-DCBL 179  
RT-4420-DCVT 179  
RT-4420-SPBK 179  
RT-4420-SPBL 179  
RT-4420-SPGN 179  
RT-4420-SPRD 179  
RT-4421-BL15 177  
RT-4421-CL10 177  
RT-4421-CL20 177  
RT-4421-CT23 176  
RT-4421-CT40 176  
RT-4421-CTW10 176  
RT-4421-CTW20 176  
RT-4421-LM1 178  
RT-4421-LM2 178  
RT-4421-LM3 178  
RT-4421-LM4 178  
RT-4421-LM5 178  
RT-4421-LM6 178  
RT-4421-PM350 177  
RT-4421-SL10 175  
RT-4421-SL15 175  
RT-4421-SL20 175  
RT-4421-SL25 175  
RT-4421-SL30 175

RT-4421-SL40 175  
RT-4421-SL50 175  
RT-4421-SLW3 175  
RT-4421-SLW4 175  
RT-4421-SLW8 175  
RT-4421-V20 176  
RT-4421-V25 176  
RT-4421-V30 176  
RT-4421-V40 176  
RT-4421-V50 176  
RT-4422-10RM 178  
RT-4422-18VM 178  
RT-4422-38RM 178  
RT-4426-DBK 174  
RT-4426-OBKN 174  
RT-4426-OUVN 174  
RT-4426-UVTL-02 174  
RT-4454-14 127  
RT-4464-02 146  
RT-4474-6 163  
RT-4474-8 163  
RT-4484-16/4X6 89  
RT-4485 199  
RT-4487 164  
RT-4487-6 164  
RT-4487-10-1 164  
RT-4487-10-2 164  
RT-4487-10-3 164  
RT-4487-10-4 164  
RT-4487-11 164  
RT-4487-15 164  
RT-4487-20 164  
RT-4487-27 164  
RT-4487-35-55 164  
RT-4487-35/55 164  
RT-4487-45-10 164  
RT-4487-45-30 164  
RT-4487-45-65 164  
RT-4487-4565 164  
RT-4487G-083 209  
RT-4487G-084 209  
RT-4487G-166 209  
RT-4487G-166-4 209  
RT-4487G-181 209  
RT-4487G-182 209  
RT-4487G-183 209  
RT-4488-01 24  
RT-4488-02 24  
RT-4488-03 24  
RT-4488-04 24  
RT-4488-05 24  
RT-4488-06 24  
RT-4489STRAP 144  
RT-4490 110  
RT-4490-A 110  
RT-4490-B 110  
RT-4490BOS1 199  
RT-4490-BX 128  
RT-4490-C 110  
RT-4490-D 110  
RT-4490-E 110  
RT-4490-F 110  
RT-4491-Q1 109  
RT-4491-Q2 109  
RT-4491-Q3-2G 109  
RT-4491-Q4-2G 109  
RT-4491R2 109  
RT-4491R2-A 109  
RT-4491R2-B 109  
RT-4491R2-C 109  
RT-4491R2-D 109  
RT-4491R2-E 109  
RT-4491R2-F 109  
RT-4491R-M 109  
RT-4491R-M2 109  
RT-4492U 199,203  
RT-4494 128  
RT4494-P 128  
RT-4517-0002 53,156,159  
RT-4517-0003 53,156,159  
RT-4517-4079VF15 53,156  
RT-4517-4080F15 156,157  
RT-4517-5070F15 156,157  
RT-4517-7070F20 156,157  
RT-4517-10070F30 156  
RT-4517-10070F35 156,157  
RT-4517-10070F40 156  
RT-4517-12075F35 156,158  
RT-4517-70120F40 156,159  
RT-4517-80150F65 156,158  
RT-4517-100100F30 156  
RT-4517-100100F40 156,158  
RT-4517-100100TRAPF35 156,158  
RT-4517-100220F120 156,159  
RT-4517-230120T80F90 156,159  
RT-4517-HOSE 162  
RT-4517-IND01 53,161  
RT-4517-PB3 156,158  
RT-4517-PB4 156,158  
RT-4517-T6565F7 156,157  
RT-4517-T7993F20 156,157  
RT-4521CSA 89  
RT-4525HGA 199,203  
RT-4525KVL 16  
RT-4525TILT 89  
RT-4525TILT-A 89  
RT-4525TILT-B 89  
RT-4527EXA 113  
RT-4527EXAG 113  
RT-4527LMI3 113  
RT-4527LTOMO 113  
RT-4527QFIX 113  
RT-4529M 113  
RT-4535BOS 199  
RT-4535BOSMRI 199  
RT-4535KV 16,199  
RT-4535KV01 16,199  
RT-4535KV03 16,199  
RT-4543S 128  
RT-4543WALL 212  
RT-4544-01 133  
RT-4544KV 17,131

RT-4544KV-10 17,131  
RT-4544KV-IND 158,161  
RT-4546 125  
RT-4546-01 125  
RT-4546-02 125  
RT-4546-03 127  
RT-4546-04 127  
RT-4546-05 127  
RT-4546AA-01 126  
RT-4546AW-01 126  
RT-4546C 53,126  
RT-4546L 128  
RT-4546MRI 125  
RT-4548 89  
RT-4550CNO1 19  
RT-4550FE 19  
RT-4550GEC 19  
RT-4550GEH 19  
RT-4550GEL 19  
RT-4550GEP 19  
RT-4550GER 19  
RT-4550GER2 19  
RT-4550KVGEK 18  
RT-4550KVGEL 18  
RT-4550KVGGER 18  
RT-4550KVPBR 18  
RT-4550KVPBRPM 18  
RT-4550KVPBPH01 18  
RT-4550KVQ 24  
RT-4550KVSS3 18  
RT-4550KVSS4 18  
RT-4550KVSS5 18  
RT-4550KVSSPM 18  
RT-4550KVTAQ 18  
RT-4550KVTAQ2 18  
RT-4550PBR 19  
RT-4550SEA 19  
RT-4550SS3 19  
RT-4550SS4 19  
RT-4550TAQ 19  
RT-4550TAQ2 19  
RT-4551BAR 23  
RT-4551BAR-01 23  
RT-4551BAR-02 23  
RT-4551BAR-03 23  
RT-4551BAR-04 23  
RT-4551BAR-05 23  
RT-4551BARMRI 23  
RT-4551CART 214  
RT-4551KV 14  
RT-4551KV0 14  
RT-4551KV-01 14  
RT-4551KV2 15  
RT-4551KV-03 198  
RT-4551KV5F 15  
RT-4551KV8 15  
RT-4551KV13 15  
RT-4551KV18 15,55  
RT-4551KV19 15,55  
RT-4551KVA-ELK 14  
RT-4551KVTBHRD 14  
RT-4551KVVHRD 14  
RT-4551SRV 24  
RT-4552 79  
RT-4552A 112  
RT-4552CART 214  
RT-4552KV 16,77  
RT-4552KV-01 203  
RT-4552MRI 79  
RT-4552P 112  
RT-4558-B1 55  
RT-4558-B2 55  
RT-4558CBO2 54  
RT-4558CBO3 52  
RT-4558KV4 52,55  
RT-4558KV4-01 52,55  
RT-4588-01 55  
RT-4600-01 61  
RT-4600-01-MRI 61  
RT-4600-02 61  
RT-4600-03 66  
RT-4600-03-MRI 66  
RT-4600-10 62,67  
RT-4600-12 62,67  
RT-4600-14 62,67  
RT-4600-20 62,67  
RT-4600KV-01 16,61  
RT-4700-10 184  
RT-4800-01 142  
RT-4800-02 53  
RT-4800-100 37  
RT-4800-B1 52  
RT-4800-B2 52  
RT-4800-FS 53,144  
RT-4800-GL 142  
RT-4800-H30 142  
RT-4800-H45 142  
RT-4800-KS 53,144  
RT-4800-SR 144  
RT-5100-04 202  
RT-5100-51CE 31  
RT-5100-51CU 31  
RT-5100-51ST 31  
RT-5100-52 31  
RT-5100-53 31  
RT-5100-100 33  
RT-5100-100S 33  
RT-5100-400 33,202  
RT-5100-400S 33,202  
RT-5100-500 30  
RT-5100-500S 30  
RT-5100-700 32  
RT-5100-700S 32  
RT-5200-01 185  
RT-7001 207  
RT-7003 207  
RT-8117-3030-3 206  
RT-8117-3030-5 206  
RT-8117-3030-10 206  
RT-31051 206  
RT-31052 206  
RT-31101 206  
RT-31102 206  
RT-31152 206

# Part Number Index

RT-31202	206	VLPLV02	152,155
RT-31302	206	VLPLV02C	152,155
RT-32052	206	VLPLV02FC	152,155
RT-32102	206	VLPLV09C	152,155
RT-31033030	206	VLPLV09FC	152,155
RT-A001	105	VLPLV10C	152,155
RT-A782KSD	82	VLPLV10FC	152,155
RT-A876KSDGLF	82	VLNBRT202FC	48
RT-A889KYS	82	VLTY01CX	153,155
RT-A892KYS	82	VLTY02CX	153,155
RT-A892KYSDF	82	VLWGB03	153,154
RT-B889KYCF2	62,67	VLWGB03C	153,154
RT-B889KYCF2A	62,67	VLWGB04C	123,153,154
RT-PUMP220Q1	162	VLWGB05C	123,153,154
RT-PUMP-KIT	162		
RT-PUMPQ1	162		
RT-PUMPQ-TS	162		
T-1882BOS-E	201		
THRMFX100	140		
THRMFX101	140		
THRMFX102	140		
TRT100	40		
VL04C	153,154		
VL14C25	153		
VL0017	49,153,154		
VL0018	153,154		
VL0021	153		
VL0022	49,153,154		
VL37	153,155		
VL71FC	153,155		
VLA80C	152		
VLARM01	153,154		
VLARM01C	153,154		
VLARM01FC	153,154		
VLARM02C	153,154		
VLARM02FC	153,154		
VLB40	152		
VLB40C	152		
VLE225	152		
VLE225C	152		
VLF15	152		
VLF15C	152		
VLF15FC	152		
VLFB01	152		
VLFB01C	152		
VLFB01FC	152		
VLFB02FC	152		
VLG26C	152		
VLG26FC	152		
VLG35	152		
VLG35C	152		
VLG35FC	152		
VLG40	152		
VLG40C	152		
VLG40FC	152		
VLH90C	152		
VLJ20	152		
VLJ20C	152		
VLJ20FC	152		
VLPLV01	152,155		
VLPLV01C	152,155		
VLPLV01FC	152,155		

© 2023 CQ Medical. All rights reserved.

CQ Medical is a trademark of Medtec LLC. BoS, Fibreplast, Qfix, Positioning Patients for Life, Symphony are registered trademarks of Qfix Systems LLC.

CIVCO is a registered trademark of CIVCO Medical Solutions. Evolve, HipFix, Interloc, Medtec, Posicast, Posifix, ProtonSeries, and Uni-frame are registered trademarks of Medtec LLC.

AccuFix, AirDrive, AirDrive Caddie, AirDrive Trolley, Assure, Aqua-Brief, Aquaplast RT, BoS, Cantilever Board, Cosmas Cup, DoseMax, Encompass, FlexLock, Integrated Shim, InfinityEdge, InfinityLock, InkAlign, INSIGHT, Low-Pro, OneTouch, Portrait, ProBoard, Prone CSA Kit, QuickFix, RapidHeat, Shoulder-Loc, SingleStep, SofTouch, Stealth Beam, Tilt-Pro, Tilt-Pro Base, Variable Perf, Virtual Indexing, VacQfix, ZiFix, ZiFix Traverse are trademarks of Qfix Systems LLC. Accuform, Align, Bi-Axial Arm Support System, Body Pro-Lok, Body Pro-Lok ONE, CIVCO Radiotherapy, CIVCO RT, Clam-Lok, ClearVision, Combifix, ComfortCare, C-Qual, C-Qual M, Cybermark, DoseMatch, Feetfix, Fixator, FlexiCoil, FlexiMarc, FreedomView, FusionCoil, Helping Hands, IMRT Reinforced Thermoplastic, Iso-Align, Kneefix, Lok-Bar, Monarch, MRSeries, MultiFix, New Horizon, ONEBridge, ONEPlatform, PointCoil, PolyMark, Posiboard, Posirest, Positilt, Precise Bite, Prodigy, ProForm, Pronelok, Pron-pillo, PureVision, RediFoam, Solstice, Solstat, ThermFix, Thorawedge, TotalRT, trUpoint ARCH, Type-S, Universal Couchtop, Vac-Lok, Wing Board and ZENTEC are trademarks of Medtec LLC.

Varian, TrueBeam, Exact, Acuity, Ximatron, Calypso, HyperArc and Halcyon are trademarks of Varian Medical Systems. Lightspeed, HiSpeed, ProSpeed and Discovery are trademarks of GE Medical. Brilliance, AcQSim, Gemini Picker PQ 5000 are trademarks of Philips Medical Systems. SOMATOM, ZXT and TXT are trademarks of Siemens AG. MAGNETOM Aera, Skyra and Vida are trademarks of Siemens. Precise and Medical Intelligence I-Beam are trademarks of Elekta AB. Kevlar and Tyvek are trademarks of E.I. DuPont de Nemours and Company. Sharpie is a trademark of Sanford L.P. DecoColor is a trademark of Uchida of America, Corp. Pro-Tekt is a trademark of MEDRAD, INC. U.S.A. Formica is a trademark of the Formica Corporation. Suremark, Clearline, PortalMark, Visionmark, Powermark, Liquimark, and BeautyLine are registered trademarks of The Suremark Company. ShadowForm is a trademark of IZI Medical Products. Staph-Chek is a registered trademark of Morrison Medical. Bolx I and Bolx II are registered trademarks of Action Products. RectalPro is a trademark of QLRAD. SpringLoc is a trademark of SchureMed. FCT Embrace is a registered trademark of Fujifilm Medical Systems USA, Inc. GrayDuck Stents and GrayDuck Dart are trademarks of POLL Medical. Grip Rings is a trademark of VanArsdale Innovative Products, Inc. Spee-D-Mark is a trademark of PDC.

The following products or their accessories or components are patented or patent(s) pending in the US and/or elsewhere by Qfix Systems LLC or licensed by Qfix Systems LLC. Encompass, SRS Adapter, SRS Cushion Support, AirDrive Trolley, AirShuttle Devices, AirDrive Caddie, ZiFix, ZiFix Traverse, kVue Access 360 G2, Virtual Indexing, Integrated Shim, kVue, DoseMax, AccuFix, IntegraBite, Encompass 15-Channel Head Coil, and FlexLock. The following products or their accessories or components are patented or patent(s) pending in the US and/or elsewhere by Medtec LLC or licensed by Medtec LLC. Body Pro-Lok ONE, Body Pro-Lok, Evolve, Solstice, Solstat, ThermFix, trUpoint ARCH, Universal Couchtop Long Extension. These lists may not be all inclusive.

This catalog contains information about products which may or may not be available in particular countries. Each country has specific laws and regulations governing the commercialization of medical devices and the communication of information regarding medical devices in printed and digital media. Products appearing in this catalog or on our website may or may not have received approval, clearance, or marketing authorization by a governmental regulatory body in any particular country, or may have received approval, clearance, or marketing authorization for different indications and restrictions in different countries, or may be for investigational use only. A product's appearance in this catalog should not be construed as a solicitation or promotion for said product, nor any indication which is not authorized by the laws and regulations of the country where the reader resides. All products may not be licensed in accordance with Canadian law.

visionrt | COMPATIBLE

## VISIONRT COMPATIBILITY

The following products have been identified as VisionRT Compatible: ClearVision & ClearVision 2 Head Only and Head, Neck & Shoulders, Solstice SRS & Solstat Immobilization Systems with ClearVision mask and Precise Bite, Encompass SRS Immobilization System with Assure Open View Fibreplast Head Only mask, Aquaplast RT Custom Bolus, Assure Open View Head, Neck & Shoulder mask.

- Vision RT is unable to comment on, nor make claims, about the immobilization rigidity, Dosimetric properties, clinical effectiveness, or patient alignment reproducibility when using these products.
- Compatibility is subject to users following vendor guidelines when using these products in conjunction with Surface Guided Radiotherapy systems, and subject to users following Vision RT's guidelines for drawing Regions of Interest for use in treatment.
- The vendor of the products is responsible for ensuring that users are in receipt of guidelines for using these products in conjunction with Surface Guided Radiotherapy systems. Vendors may change their guidelines from time to time without reviewing changes with Vision RT. Vision RT is not liable for misuse of the products.
- Vision RT makes no comment on, and is not liable for, suitability or otherwise of use of these products for the respective procedure(s) for which they are advertised or any other procedure.
- Purchasers are responsible for making their own choices as to the products selected by them.





[info@CQmedical.com](mailto:info@CQmedical.com) | [www.CQmedical.com](http://www.CQmedical.com)

